

Tiny 2350 (PIM721)

USB-C connector

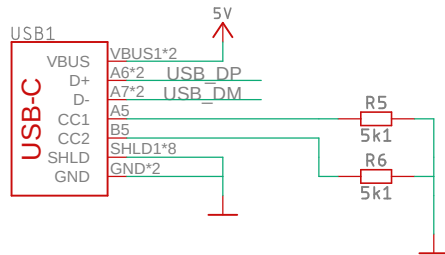

RGB LED

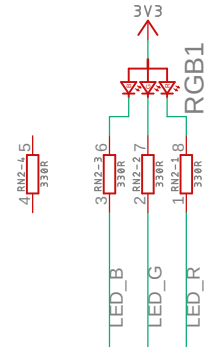

RP2350 MCU

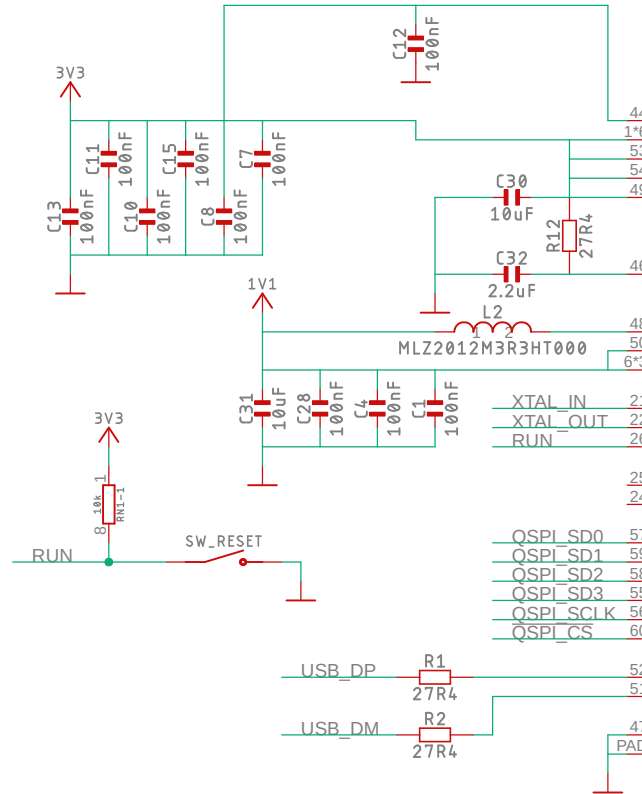

MCU2

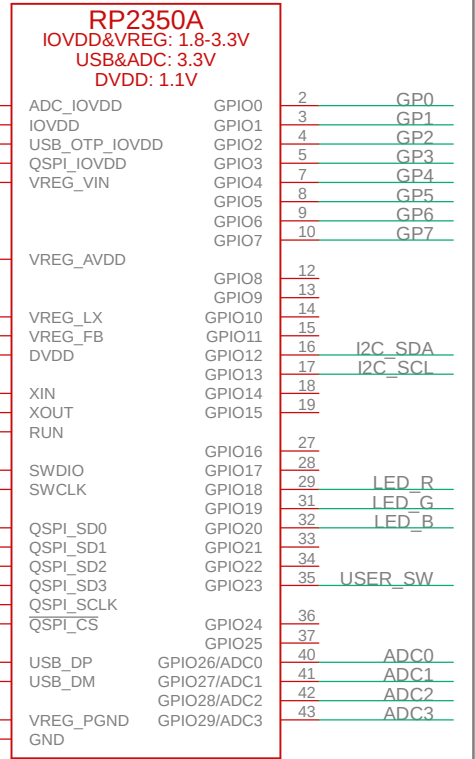

LDO

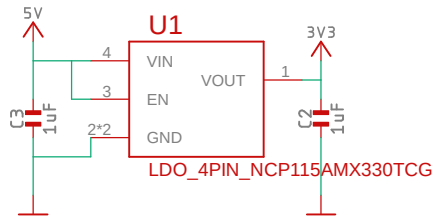

QW/ST connector

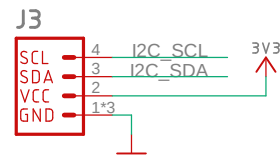

Output headers

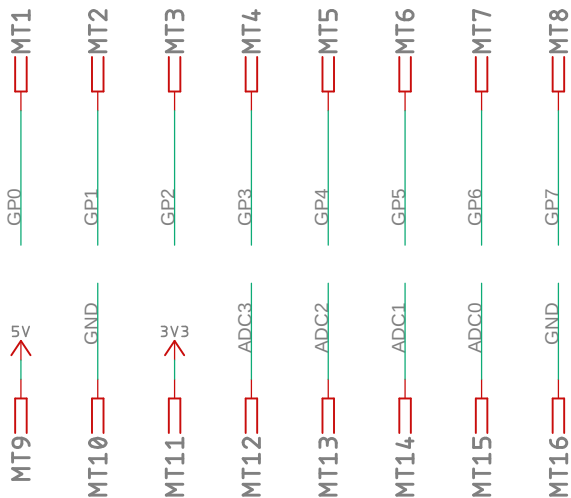

Crystal oscillator

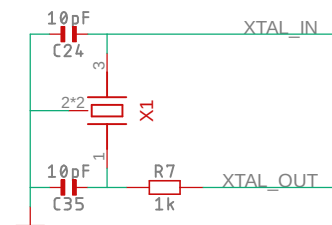

Flash memory, 8MB

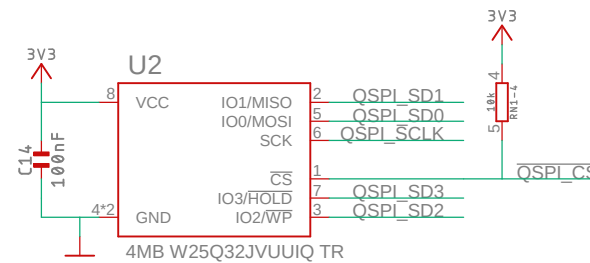

Combined USB boot & user switch

