

LME49720 Dual High Performance, High Fidelity Audio Operational Amplifier

1 Features

- Easily Drives 600Ω Loads
- Optimized for Superior Audio Signal Fidelity
- Output Short Circuit Protection
- PSRR and CMRR Exceed 120dB (typ)
- SOIC, PDIP, TO-99 Metal Can Packages
- Key Specifications
 - Power Supply Voltage Range: ± 2.5 to $\pm 17V$
 - THD+N ($A_V = 1$, $V_{OUT} = 3V_{RMS}$, $f_{IN} = 1kHz$):
 - $R_L = 2k\Omega$: 0.00003% (typ)
 - $R_L = 600\Omega$: 0.00003% (typ)
 - Input Noise Density: $2.7nV/\sqrt{Hz}$ (typ)
 - Slew Rate: $\pm 20V/\mu s$ (typ)
 - Gain Bandwidth Product: 55MHz (typ)
 - Open Loop Gain ($R_L = 600\Omega$): 140dB (typ)
 - Input Bias Current: 10nA (typ)
 - Input Offset Voltage: 0.1mV (typ)
 - DC Gain Linearity Error: 0.000009%

2 Applications

- Ultra High Quality Audio Amplification
- High Fidelity Preamplifiers
- High Fidelity Multimedia
- State of the Art Phono Pre Amps
- High Performance Professional Audio
- High Fidelity Equalization and Crossover Networks
- High Performance Line Drivers
- High Performance Line Receivers
- High Fidelity Active Filters

3 Description

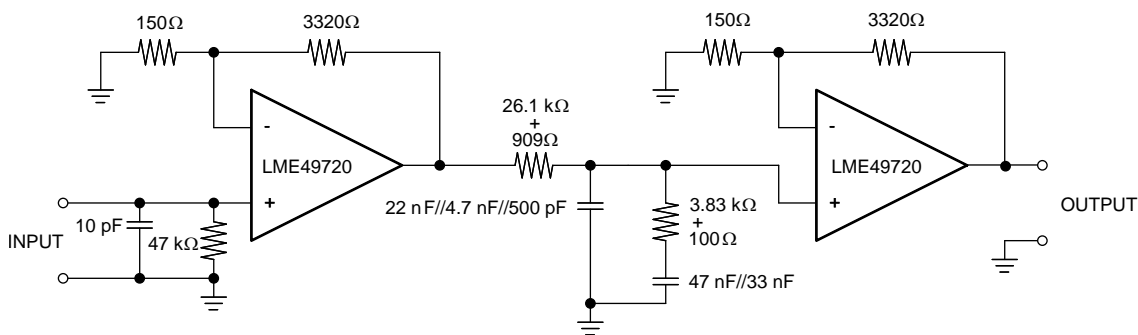
The LME49720 device is part of the ultra-low distortion, low noise, high slew rate operational amplifier series optimized and fully specified for high performance, high fidelity applications. Combining advanced leading-edge process technology with state-of-the-art circuit design, the LME49720 audio operational amplifiers deliver superior audio signal amplification for outstanding audio performance. The LME49720 combines extremely low voltage noise density ($2.7nV/\sqrt{Hz}$) with vanishingly low THD+N (0.00003%) to easily satisfy the most demanding audio applications.

Device Information⁽¹⁾

| PART NUMBER | PACKAGE | BODY SIZE (NOM) |
|-------------|-----------|-----------------|
| LME49720 | TO-99 (8) | 9.08mm x 9.08mm |
| | SOIC (8) | 4.90mm x 3.91mm |
| | PDIP (8) | 9.81mm x 6.35mm |

(1) For all available packages, see the orderable addendum at the end of the data sheet.

Passively Equalized RIAA Phono Preampifier



Note: 1% metal film resistors, 5% polypropylene capacitors

Copyright © 2016, Texas Instruments Incorporated



Table of Contents

| | |
|---|---|
| 1 Features 1 2 Applications 1 3 Description 1 4 Revision History 2 5 Device Comparison Table 3 6 Pin Configuration and Functions 3 7 Specifications 4 7.1 Absolute Maximum Ratings 4 7.2 ESD Ratings..... 4 7.3 Recommended Operating Conditions 4 7.4 Thermal Information 4 7.5 Electrical Characteristics 5 7.6 Typical Characteristics 6 8 Parameter Measurement Information 24 8.1 Distortion Measurements 24 9 Detailed Description 26 9.1 Overview 26 9.2 Functional Block Diagram 26 | 9.3 Feature Description..... 26 9.4 Device Functional Modes..... 27 10 Application and Implementation 27 10.1 Application Information..... 27 10.2 Typical Applications 27 11 Power Supply Recommendations 35 11.1 Power Supply Decoupling Capacitors 35 12 Layout 36 12.1 Layout Guidelines 36 12.2 Layout Example 36 13 Device and Documentation Support 39 13.1 Receiving Notification of Documentation Updates 39 13.2 Community Resources..... 39 13.3 Trademarks 39 13.4 Electrostatic Discharge Caution..... 39 13.5 Glossary 39 14 Mechanical, Packaging, and Orderable Information 39 |
|---|---|

4 Revision History

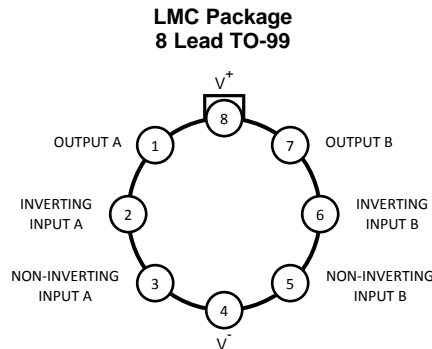
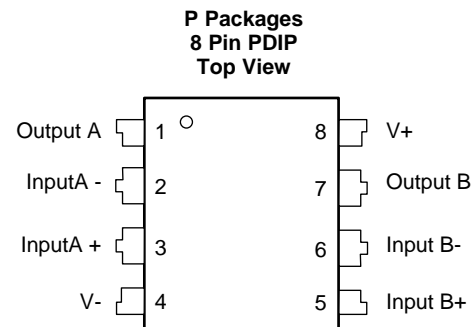
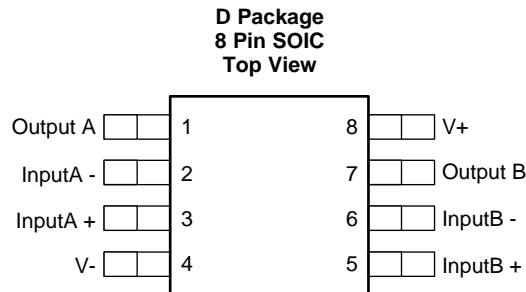
NOTE: Page numbers for previous revisions may differ from page numbers in the current version.

| Changes from Revision C (April 2013) to Revision D | Page |
|---|------|
| <ul style="list-style-type: none"> • Added <i>Device Information</i> table, <i>ESD Ratings</i> table, <i>Feature Description</i> section, <i>Device Functional Modes</i>, <i>Power Supply Recommendations</i> section, <i>Layout</i> section, <i>Device and Documentation Support</i> section, and <i>Mechanical, Packaging, and Orderable Information</i> section. 1 | |
| <ul style="list-style-type: none"> • Changed $R_{\theta JA}$ values for D and P packages from 145 °C/W to 107.9 °C/W (D) and from 102 °C/W to 72.9 °C/W (P) in the <i>Thermal Information</i> table..... 4 | 4 |

5 Device Comparison Table

| Device Number | Amplifier Type | Number of Channel | Output Current (mA) | Input Noise Density (nV/rtHz) | THD+N (%) |
|---------------|-------------------|-------------------|---------------------|-------------------------------|-----------|
| LME49710 | Audio Operational | 1 | 37 | 2.5 | 0.00003 |
| LME49720 | Audio Operational | 2 | 26 | 2.7 | 0.00003 |
| LME49721 | Audio Operational | 2 | 100 | 4 | 0.0002 |
| LME49723 | Audio Operational | 2 | 25 | 3.2 | 0.0002 |

6 Pin Configuration and Functions



Pin Functions

| NAME | PIN | | | I/O | DESCRIPTION |
|----------|------|------|-------|-----|-------------------------|
| | SOIC | PDIP | TO-99 | | |
| V+ | 8 | 8 | 8 | - | Positive supply voltage |
| V- | 4 | 4 | 4 | - | Negative supply voltage |
| InputA- | 2 | 2 | 2 | I | Negative audio input |
| InputA+ | 3 | 3 | 3 | I | Positive audio input |
| Output A | 1 | 1 | 1 | O | Audio output A |
| InputB- | 6 | 6 | 6 | I | Negative audio input |
| InputB+ | 5 | 5 | 5 | I | Positive audio input |
| Output B | 7 | 7 | 7 | O | Audio output B |

7 Specifications

7.1 Absolute Maximum Ratings

 see ⁽¹⁾⁽²⁾⁽³⁾

| | | MIN | MAX | UNIT |
|-------------------------------------|---------------------------------|----------------------------------|---------------|------|
| Power Supply Voltage | $(V_S = V^+ - V^-)$ | | 36 | V |
| Input Voltage | | $(V^-) - 0.7V$ | $(V^+) + 0.7$ | V |
| Output Short Circuit ⁽⁴⁾ | | Continuous | | |
| Power Dissipation | | Internally Limited | | |
| Junction Temperature | | | 150 | °C |
| Temperature Range | $T_{MIN} \leq T_A \leq T_{MAX}$ | -40 | 85 | °C |
| Supply Voltage Range | | $\pm 2.5V \leq V_S \leq \pm 17V$ | | V |
| Storage Temperature | | -65 | 150 | °C |

- (1) Absolute Maximum Ratings indicate limits beyond which damage to the device may occur.
- (2) Operating Ratings indicate conditions for which the device is functional, but do not ensure specific performance limits. For ensured specifications and test conditions, see Electrical Characteristics. The ensured specifications apply only for the test conditions listed. Some performance characteristics may degrade when the device is not operated under the listed test conditions.
- (3) If Military/Aerospace specified devices are required, please contact the Texas Instruments Sales Office/ Distributors for availability and specifications.
- (4) Amplifier output connected to GND, any number of amplifiers within a package.

7.2 ESD Ratings

| | | | VALUE | UNIT |
|-------------|-------------------------|---|--------------------|------|
| $V_{(ESD)}$ | Electrostatic discharge | Human-body model (HBM) ⁽¹⁾ | All pins | 2000 |
| | | Machine Model (MM), per EIAJ IC-121-1981 Application and Implementation | Pins 1, 4, 7 and 8 | 200 |
| | | | Pins 2, 3, 5 and 6 | 100 |

- (1) Human body model, 100pF discharged through a 1.5kΩ resistor.

7.3 Recommended Operating Conditions

over operating free-air temperature range (unless otherwise noted)

| | | MIN | NOM | MAX | UNIT |
|------------|--------------------------------|-----------|-----|----------|------|
| V^+, V^- | Supply voltage | ± 2.5 | | ± 17 | V |
| T_A | Operating free-air temperature | -40 | | 85 | °C |
| T_J | Operating junction temperature | -40 | | 150 | °C |

7.4 Thermal Information

| THERMAL METRIC ⁽¹⁾ | LME49720 | | | UNIT | |
|-------------------------------|--|----------|----------------------------|------|------|
| | D (SOIC) | P (PDIP) | LMC (TO-99) ⁽²⁾ | | |
| | 8 PINS | 8 PINS | 8 PINS | | |
| $R_{\theta JA}$ | Junction-to-ambient thermal resistance | 107.9 | 72.9 | 150 | °C/W |
| $R_{\theta JC(top)}$ | Junction-to-case (top) thermal resistance | 52 | 77.2 | 35 | °C/W |
| $R_{\theta JB}$ | Junction-to-board thermal resistance | 48.3 | 44.9 | – | °C/W |
| ψ_{JT} | Junction-to-top characterization parameter | 8.2 | 35.7 | – | °C/W |
| ψ_{JB} | Junction-to-board characterization parameter | 47.8 | 49.9 | – | °C/W |
| $R_{\theta JC(bot)}$ | Junction-to-case (bottom) thermal resistance | N/A | N/A | – | °C/W |

- (1) For more information about traditional and new thermal metrics, see the [Semiconductor and IC Package Thermal Metrics](#) application report.
- (2) Thermal performance of a TO-99 package will depend strongly on mounting condition and there is no standard mounting configuration on a JEDEC PCB for that package type.

7.5 Electrical Characteristics

The following specifications apply for $V_S = \pm 15V$, $R_L = 2k\Omega$, $f_{IN} = 1kHz$, and $T_A = 25^\circ C$, unless otherwise specified.

| PARAMETER | | TEST CONDITIONS | MIN ⁽¹⁾ | TYP ⁽²⁾ | MAX ⁽¹⁾ | UNIT |
|--------------------------------|--|--|--------------------------|--------------------|--------------------|------------------|
| THD+N | Total harmonic distortion + noise | $A_V = 1$, $V_{OUT} = 3V_{rms}$ $R_L = 2k\Omega$ $R_L = 600\Omega$ | | 0.00003 0.00003 | 0.00009 | % |
| IMD | Intermodulation distortion | $A_V = 1$, $V_{OUT} = 3V_{RMS}$ Two-tone, 60Hz & 7kHz 4:1 | | 0.00005 | | % |
| GBWP | Gain bandwidth product | | 45 | 55 | | MHz |
| SR | Slew rate | | ± 15 | ± 20 | | V/ μs |
| FPBW | Full power bandwidth | $V_{OUT} = 1V_{P-P}$, $-3dB$ referenced to output magnitude at $f = 1kHz$ | | 10 | | MHz |
| t_s | Settling time | $A_V = -1$, 10V step, $C_L = 100pF$ 0.1% error range | | 1.2 | | μs |
| e_n | Equivalent input noise voltage | $f_{BW} = 20Hz$ to 20kHz | | 0.34 | 0.65 | μV_{RMS} |
| | Equivalent input noise density | $f = 1kHz$ $f = 10Hz$ | | 2.7 6.4 | 4.7 | nV/\sqrt{Hz} |
| i_n | Current noise density | $f = 1kHz$ $f = 10Hz$ | | 1.6 3.1 | | pA/\sqrt{Hz} |
| V_{OS} | Offset voltage | | | ± 0.1 | ± 0.7 | mV |
| $\Delta V_{OS}/\Delta T_{emp}$ | Average input offset voltage drift vs temperature | $-40^\circ C \leq T_A \leq 85^\circ C$ | | 0.2 | | $\mu V/^\circ C$ |
| PSRR | Average input offset voltage shift vs power supply voltage | $\Delta V_S = 20V$ ⁽³⁾ | 110 | 120 | | dB |
| ISO _{CH-CH} | Channel-to-Channel isolation | $f_{IN} = 1kHz$ $f_{IN} = 20kHz$ | | 118 112 | | dB |
| I_B | Input bias current | $V_{CM} = 0V$ | | 10 | 72 | nA |
| $\Delta I_{OS}/\Delta T_{emp}$ | Input bias current drift vs temperature | $-40^\circ C \leq T_A \leq 85^\circ C$ | | 0.1 | | $nA/^\circ C$ |
| I_{OS} | Input offset current | $V_{CM} = 0V$ | | 11 | 65 | nA |
| V_{IN-CM} | Common-Mode input voltage range | | (V+) – 2.0 (V-) + 2.0 | +14.1 –13.9 | | V |
| CMRR | Common-Mode rejection | $-10V < V_{cm} < 10V$ | 110 | 120 | | dB |
| Z_{IN} | Differential input impedance | | | 30 | | k Ω |
| | Common mode input impedance | $-10V < V_{cm} < 10V$ | | 1000 | | M Ω |
| A_{VOL} | Open loop voltage gain | $-10V < V_{out} < 10V$, $R_L = 600\Omega$ | 125 | 140 | | dB |
| | | $-10V < V_{out} < 10V$, $R_L = 2k\Omega$ | | 140 | | |
| | | $-10V < V_{out} < 10V$, $R_L = 10k\Omega$ | | 140 | | |
| V_{OUTMAX} | Maximum output voltage swing | $R_L = 600\Omega$ | ± 12.5 | ± 13.6 | | V |
| | | $R_L = 2k\Omega$ | | ± 14.0 | | |
| | | $R_L = 10k\Omega$ | | ± 14.1 | | |
| I_{OUT} | Output current | $R_L = 600\Omega$, $V_S = \pm 17V$ | ± 23 | ± 26 | | mA |
| I_{OUT-CC} | Instantaneous short circuit current | | | +53 –42 | | mA |
| R_{OUT} | Output impedance | $f_{IN} = 10kHz$ Closed-Loop Open-Loop | | 0.01 13 | | Ω |
| C_{LOAD} | Capacitive load drive overshoot | 100pF | | 16 | | % |
| I_S | Total quiescent current | $I_{OUT} = 0mA$ | | 10 | 12 | mA |

(1) Tested limits are ensured to AOQL (Average Outgoing Quality Level).

(2) Typical specifications are specified at $+25^\circ C$ and represent the most likely parametric norm.

(3) PSRR is measured as follows: V_{OS} is measured at two supply voltages, $\pm 5V$ and $\pm 15V$. $PSRR = |20\log(\Delta V_{OS}/\Delta V_S)|$.

7.6 Typical Characteristics

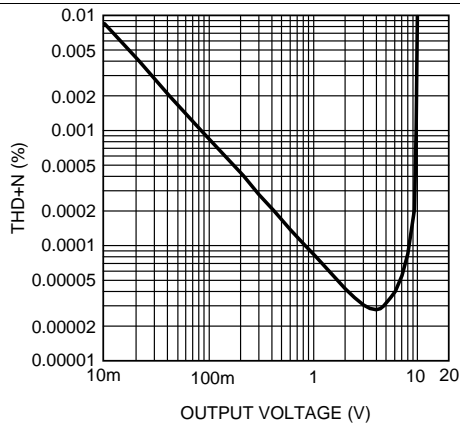


Figure 1. Thd+N vs Output Voltage $V_{CC} = 15V$, $V_{EE} = -15V$ $R_L = 2k\Omega$

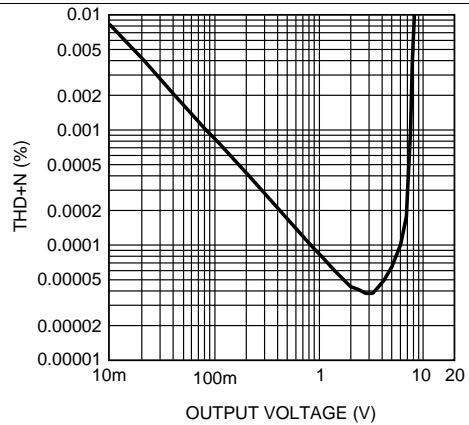


Figure 2. Thd+N vs Output Voltage $V_{CC} = 12V$, $V_{EE} = -12V$ $R_L = 2k\Omega$

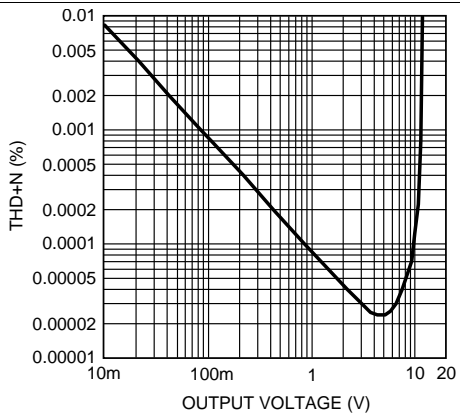


Figure 3. Thd+N vs Output Voltage $V_{CC} = 17V$, $V_{EE} = -17V$ $R_L = 2k\Omega$

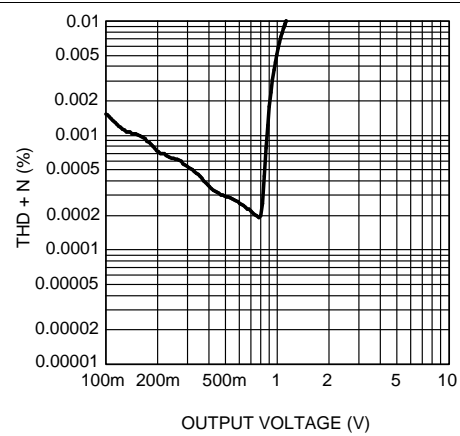


Figure 4. Thd+N vs Output Voltage $V_{CC} = 2.5V$, $V_{EE} = -2.5V$ $R_L = 2k\Omega$

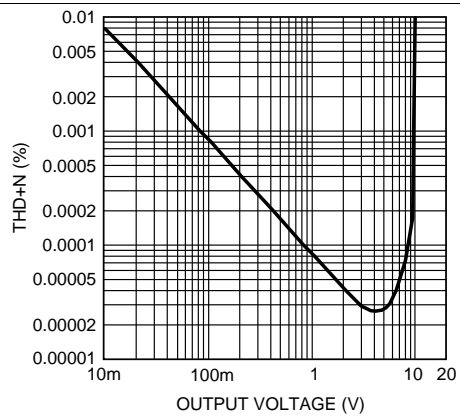


Figure 5. Thd+N vs Output Voltage $V_{CC} = 15V$, $V_{EE} = -15V$ $R_L = 600\Omega$

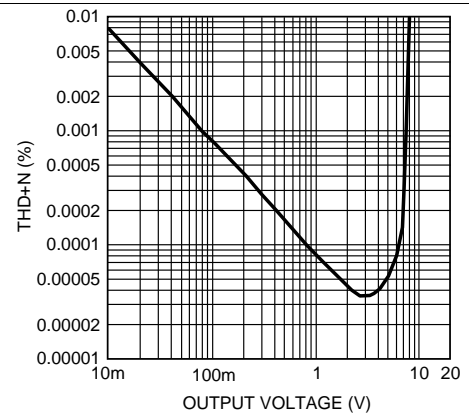


Figure 6. Thd+N vs Output Voltage $V_{CC} = 12V$, $V_{EE} = -12V$ $R_L = 600\Omega$

Typical Characteristics (continued)

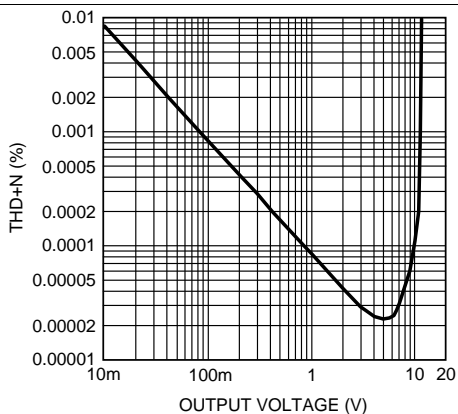


Figure 7. Thd+N vs Output Voltage $V_{CC} = 17V$, $V_{EE} = -17V$ $R_L = 600\Omega$

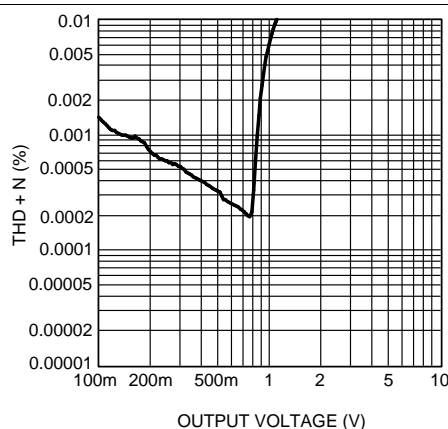


Figure 8. Thd+N vs Output Voltage $V_{CC} = 2.5V$, $V_{EE} = -2.5V$ $R_L = 600\Omega$

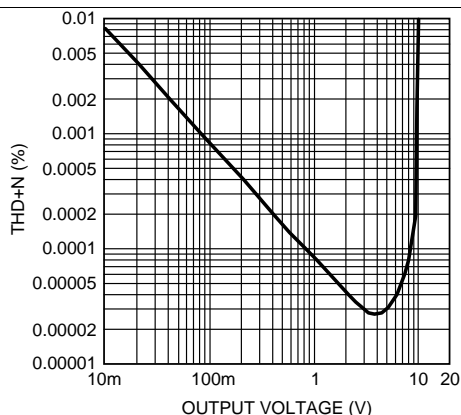


Figure 9. Thd+N vs Output Voltage $V_{CC} = 15V$, $V_{EE} = -15V$ $R_L = 10k\Omega$

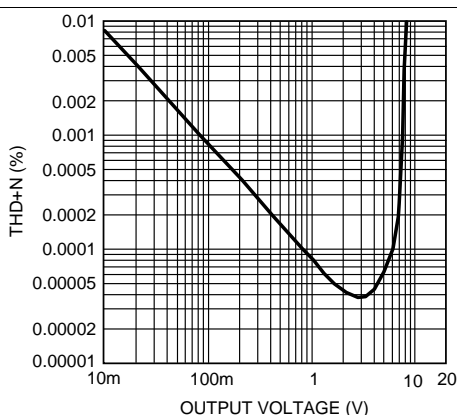


Figure 10. Thd+N vs Output Voltage $V_{CC} = 12V$, $V_{EE} = -12V$ $R_L = 10k\Omega$

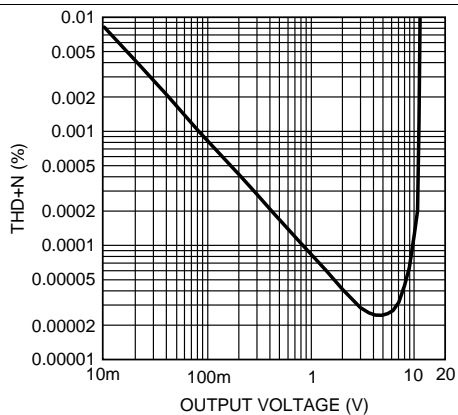


Figure 11. Thd+N vs Output Voltage $V_{CC} = 17V$, $V_{EE} = -17V$ $R_L = 10k\Omega$

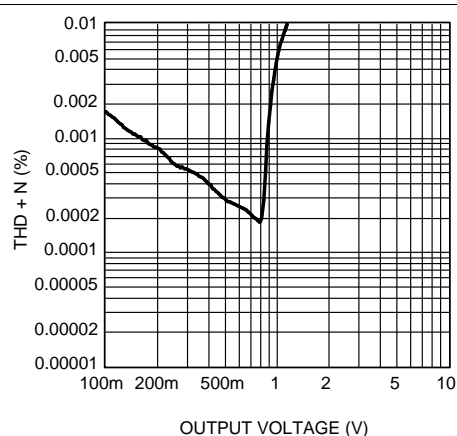


Figure 12. Thd+N vs Output Voltage $V_{CC} = 2.5V$, $V_{EE} = -2.5V$ $R_L = 10k\Omega$

Typical Characteristics (continued)

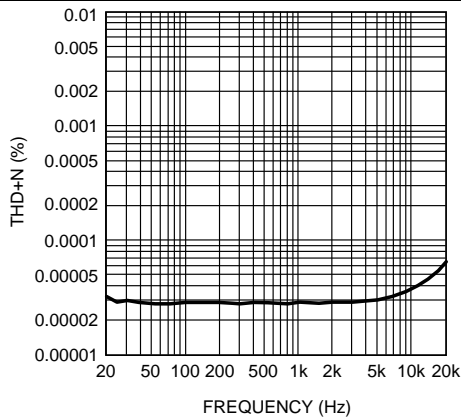


Figure 13. Thd+N vs Frequency $V_{CC} = 15V$, $V_{EE} = -15V$, $V_{OUT} = 3V_{RMS}$ $R_L = 2k\Omega$

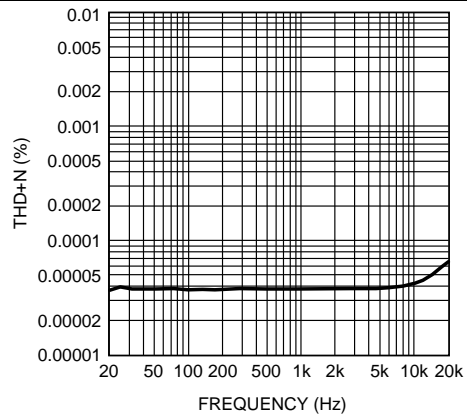


Figure 14. Thd+N vs Frequency $V_{CC} = 12V$, $V_{EE} = -12V$, $V_{OUT} = 3V_{RMS}$ $R_L = 2k\Omega$

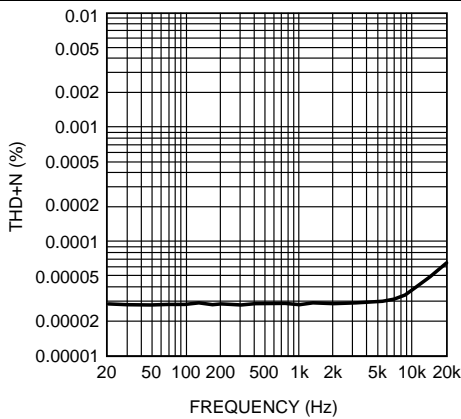


Figure 15. Thd+N vs Frequency $V_{CC} = 17V$, $V_{EE} = -17V$, $V_{OUT} = 3V_{RMS}$ $R_L = 2k\Omega$

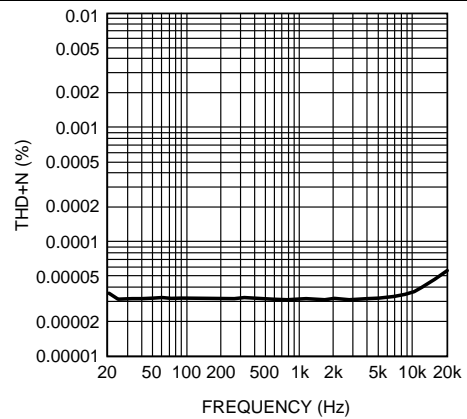


Figure 16. Thd+N vs Frequency $V_{CC} = 15V$, $V_{EE} = -15V$, $V_{OUT} = 3V_{RMS}$ $R_L = 600\Omega$

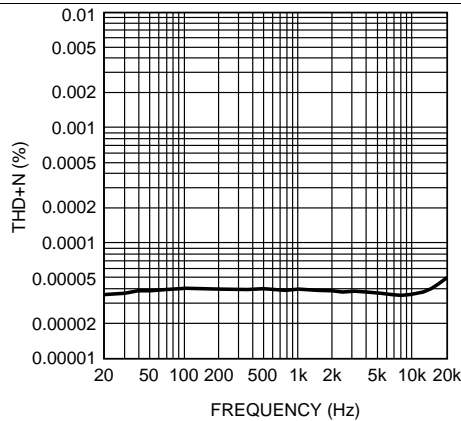


Figure 17. Thd+N vs Frequency $V_{CC} = 12V$, $V_{EE} = -12V$, $V_{OUT} = 3V_{RMS}$ $R_L = 600\Omega$

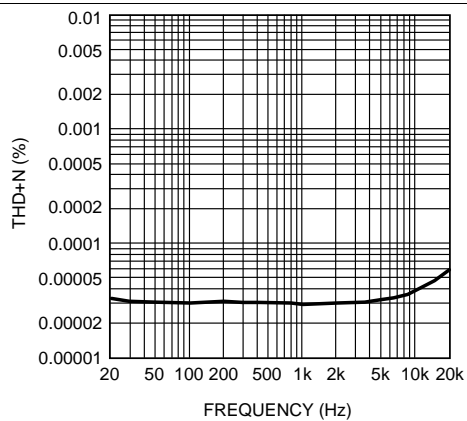


Figure 18. Thd+N vs Frequency $V_{CC} = 17V$, $V_{EE} = -17V$, $V_{OUT} = 3V_{RMS}$ $R_L = 600\Omega$

Typical Characteristics (continued)

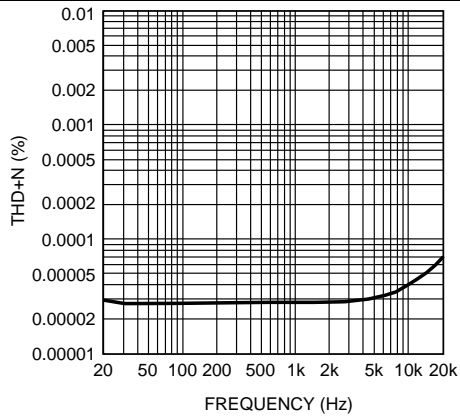


Figure 19. Thd+N vs Frequency $V_{CC} = 15V$, $V_{EE} = -15V$, $V_{OUT} = 3V_{RMS}$ $R_L = 10k\Omega$

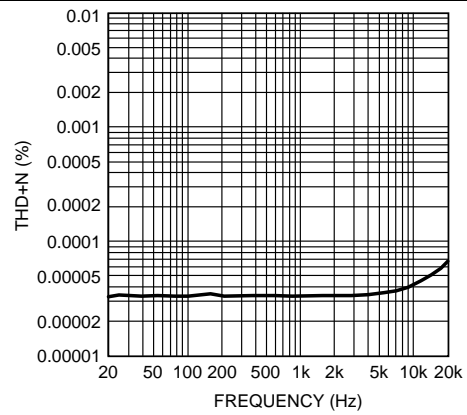


Figure 20. Thd+N vs Frequency $V_{CC} = 12V$, $V_{EE} = -12V$, $V_{OUT} = 3V_{RMS}$ $R_L = 10k\Omega$

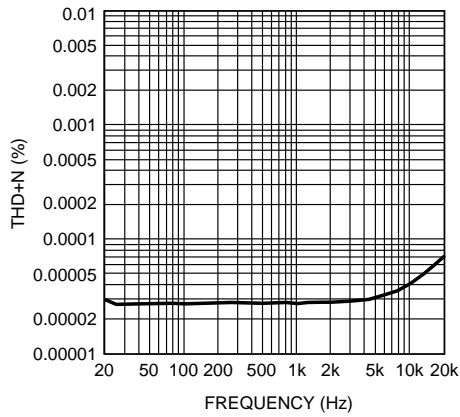


Figure 21. Thd+N vs Frequency $V_{CC} = 17V$, $V_{EE} = -17V$, $V_{OUT} = 3V_{RMS}$ $R_L = 10k\Omega$

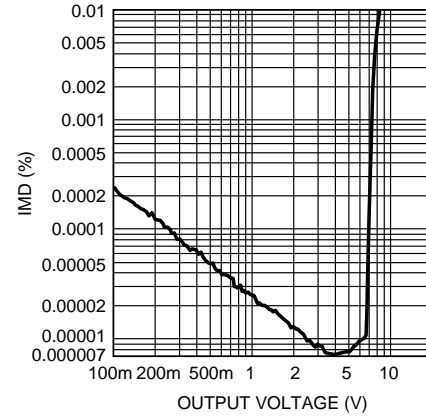


Figure 22. IMD vs Output Voltage $V_{CC} = 15V$, $V_{EE} = -15V$ $R_L = 2k\Omega$

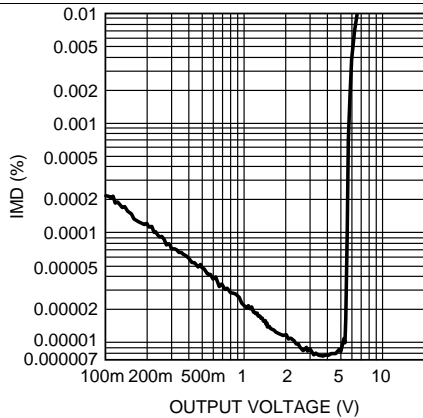


Figure 23. IMD vs Output Voltage $V_{CC} = 12V$, $V_{EE} = -12V$ $R_L = 2k\Omega$

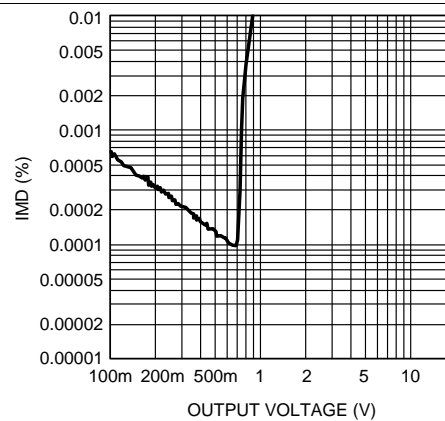
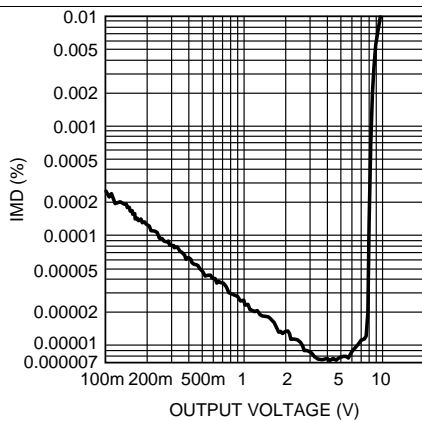
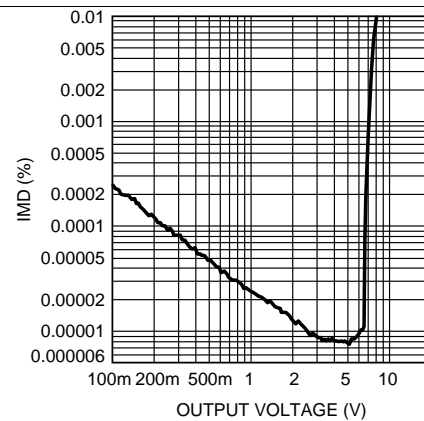
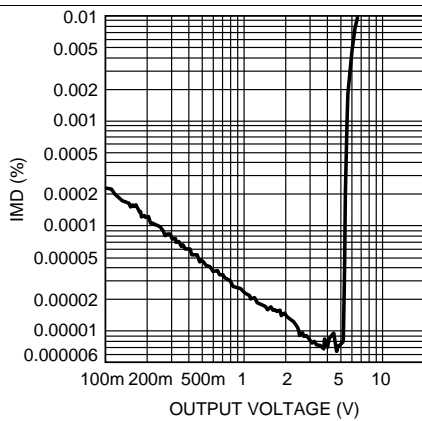
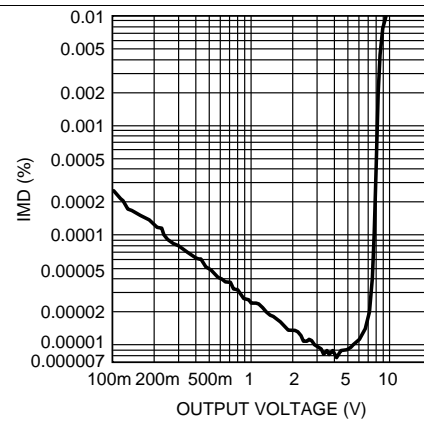
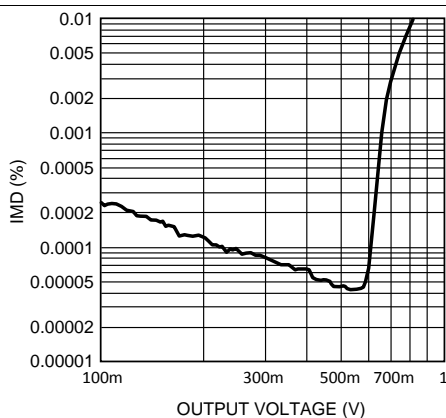
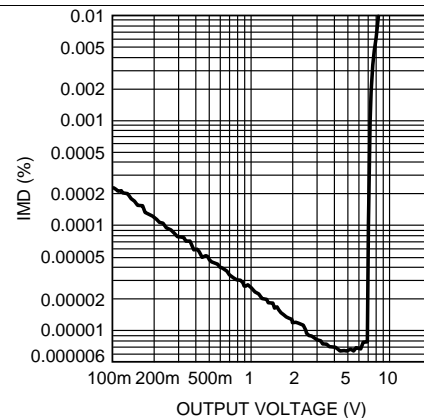


Figure 24. IMD vs Output Voltage $V_{CC} = 2.5V$, $V_{EE} = -2.5V$ $R_L = 2k\Omega$

Typical Characteristics (continued)

Figure 25. IMD vs Output Voltage $V_{CC} = 17V$, $V_{EE} = -17V$ $R_L = 2k\Omega$

Figure 26. IMD vs Output Voltage $V_{CC} = 15V$, $V_{EE} = -15V$ $R_L = 600\Omega$

Figure 27. IMD vs Output Voltage $V_{CC} = 12V$, $V_{EE} = -12V$ $R_L = 600\Omega$

Figure 28. IMD vs Output Voltage $V_{CC} = 17V$, $V_{EE} = -17V$ $R_L = 600\Omega$

Figure 29. IMD vs Output Voltage $V_{CC} = 2.5V$, $V_{EE} = -2.5V$ $R_L = 600\Omega$

Figure 30. IMD vs Output Voltage $V_{CC} = 15V$, $V_{EE} = -15V$ $R_L = 10k\Omega$

Typical Characteristics (continued)

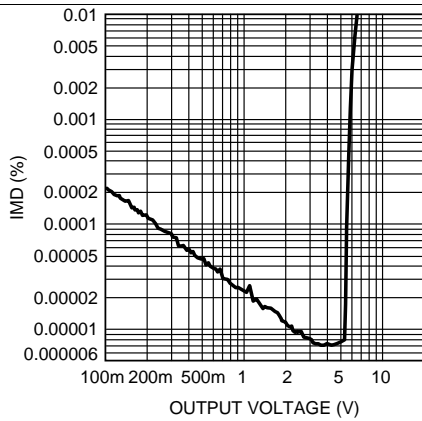


Figure 31. IMD vs Output Voltage $V_{CC} = 12V$, $V_{EE} = -12V$ $R_L = 10k\Omega$

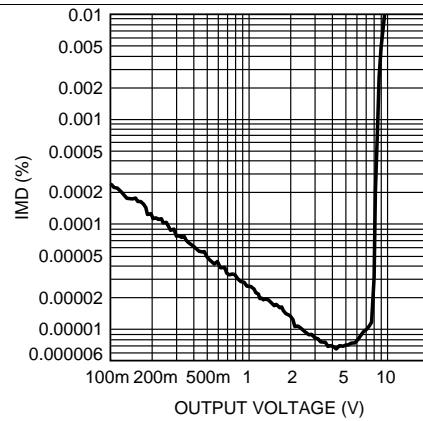


Figure 32. IMD vs Output Voltage $V_{CC} = 17V$, $V_{EE} = -17V$ $R_L = 10k\Omega$

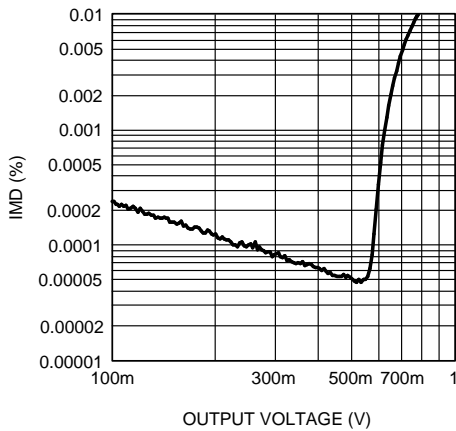


Figure 33. IMD vs Output Voltage $V_{CC} = 2.5V$, $V_{EE} = -2.5V$ $R_L = 10k\Omega$

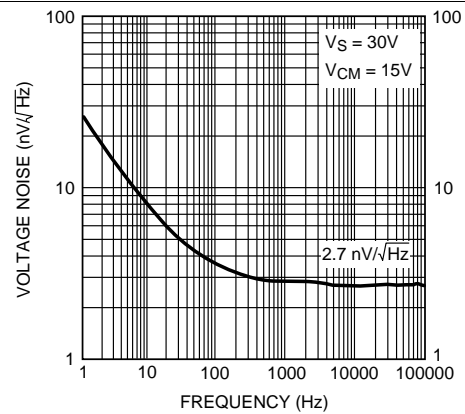


Figure 34. Voltage Noise Density vs Frequency

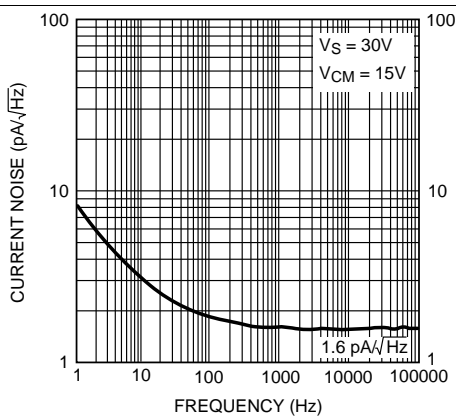


Figure 35. Current Noise Density vs Frequency

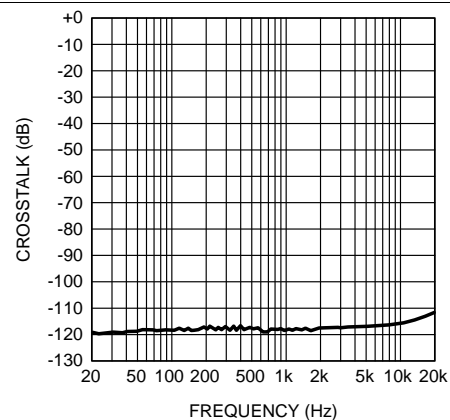


Figure 36. Crosstalk vs Frequency $V_{CC} = 15V$, $V_{EE} = -15V$, $V_{OUT} = 3V_{RMS}$ $A_V = 0dB$, $R_L = 2k\Omega$

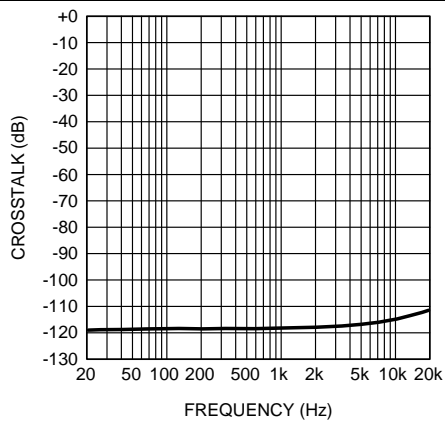
Typical Characteristics (continued)


Figure 37. Crosstalk vs Frequency $V_{CC} = 15V$, $V_{EE} = -15V$, $V_{OUT} = 10V_{RMS}$ $A_V = 0dB$, $R_L = 2k\Omega$

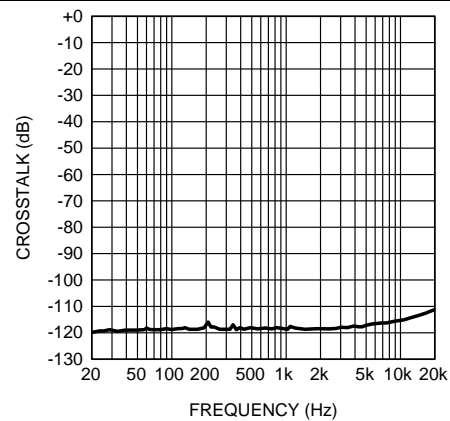


Figure 38. Crosstalk vs Frequency $V_{CC} = 12V$, $V_{EE} = -12V$, $V_{OUT} = 3V_{RMS}$ $A_V = 0dB$, $R_L = 2k\Omega$

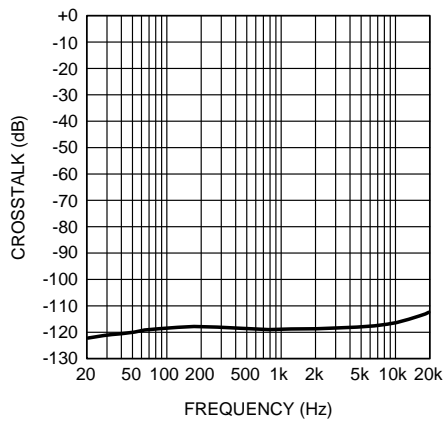


Figure 39. Crosstalk vs Frequency $V_{CC} = 12V$, $V_{EE} = -12V$, $V_{OUT} = 10V_{RMS}$ $A_V = 0dB$, $R_L = 2k\Omega$

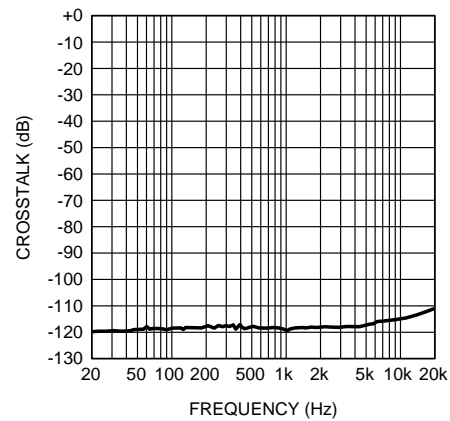


Figure 40. Crosstalk vs Frequency $V_{CC} = 17V$, $V_{EE} = -17V$, $V_{OUT} = 3V_{RMS}$ $A_V = 0dB$, $R_L = 2k\Omega$

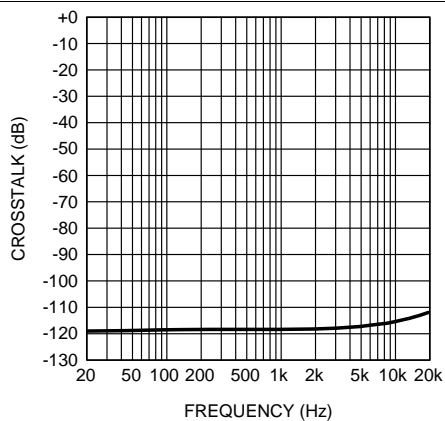


Figure 41. Crosstalk vs Frequency $V_{CC} = 17V$, $V_{EE} = -17V$, $V_{OUT} = 10V_{RMS}$ $A_V = 0dB$, $R_L = 2k\Omega$

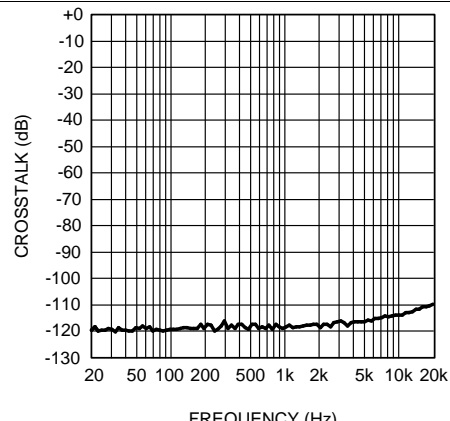


Figure 42. Crosstalk vs Frequency $V_{CC} = 2.5V$, $V_{EE} = -2.5V$, $V_{OUT} = 1V_{RMS}$ $A_V = 0dB$, $R_L = 2k\Omega$

Typical Characteristics (continued)

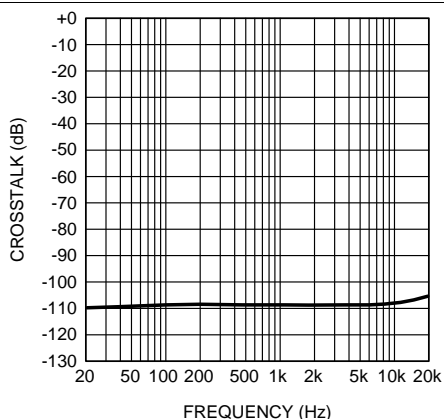


Figure 43. Crosstalk vs Frequency $V_{CC} = 15V$, $V_{EE} = -15V$, $V_{OUT} = 3V_{RMS}$ $A_V = 0dB$, $R_L = 600\Omega$

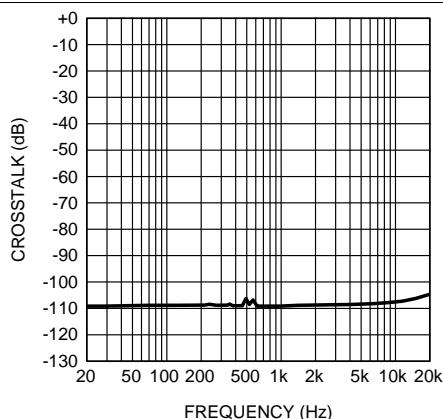


Figure 44. Crosstalk vs Frequency $V_{CC} = 15V$, $V_{EE} = -15V$, $V_{OUT} = 10V_{RMS}$ $A_V = 0dB$, $R_L = 600\Omega$

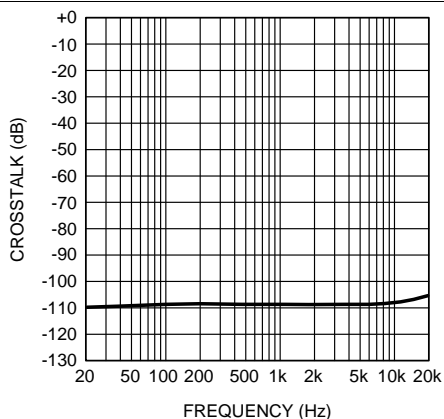


Figure 45. Crosstalk vs Frequency $V_{CC} = 12V$, $V_{EE} = -12V$, $V_{OUT} = 3V_{RMS}$ $A_V = 0dB$, $R_L = 600\Omega$

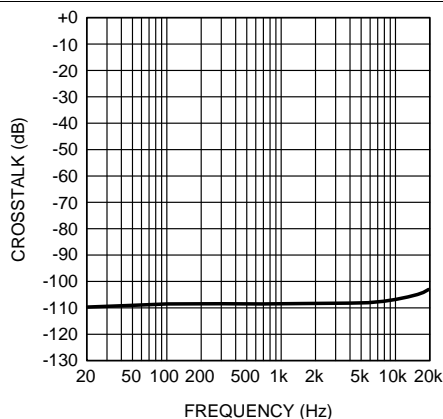


Figure 46. Crosstalk vs Frequency $V_{CC} = 12V$, $V_{EE} = -12V$, $V_{OUT} = 10V_{RMS}$ $A_V = 0dB$, $R_L = 600\Omega$

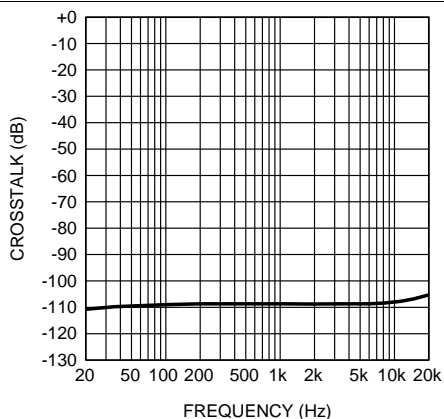


Figure 47. Crosstalk vs Frequency $V_{CC} = 17V$, $V_{EE} = -17V$, $V_{OUT} = 3V_{RMS}$ $A_V = 0dB$, $R_L = 600\Omega$

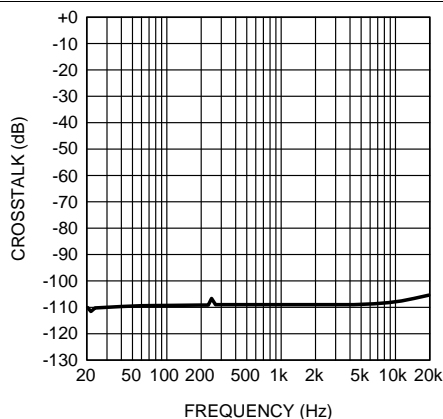


Figure 48. Crosstalk vs Frequency $V_{CC} = 17V$, $V_{EE} = -17V$, $V_{OUT} = 10V_{RMS}$ $A_V = 0dB$, $R_L = 600\Omega$

Typical Characteristics (continued)

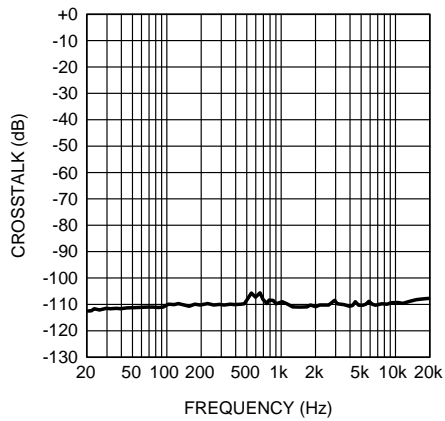


Figure 49. Crosstalk vs Frequency $V_{CC} = 2.5V$, $V_{EE} = -2.5V$, $V_{OUT} = 1V_{RMS}$ $A_V = 0dB$, $R_L = 600\Omega$

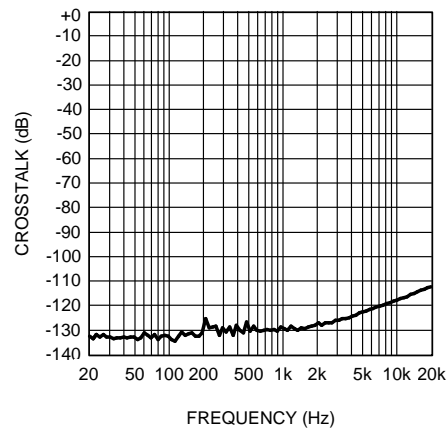


Figure 50. Crosstalk vs Frequency $V_{CC} = 15V$, $V_{EE} = -15V$, $V_{OUT} = 3V_{RMS}$ $A_V = 0dB$, $R_L = 10k\Omega$

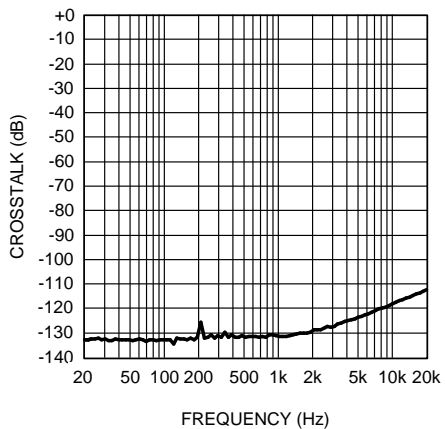


Figure 51. Crosstalk vs Frequency $V_{CC} = 15V$, $V_{EE} = -15V$, $V_{OUT} = 10V_{RMS}$ $A_V = 0dB$, $R_L = 10k\Omega$

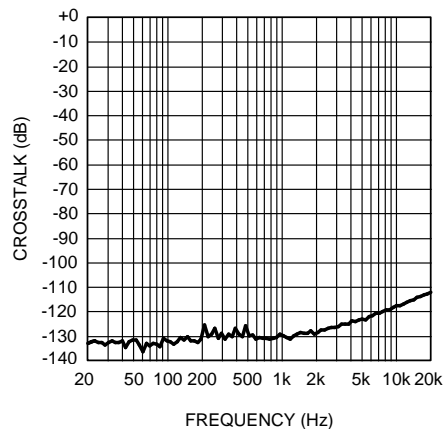


Figure 52. Crosstalk vs Frequency $V_{CC} = 12V$, $V_{EE} = -12V$, $V_{OUT} = 3V_{RMS}$ $A_V = 0dB$, $R_L = 10k\Omega$

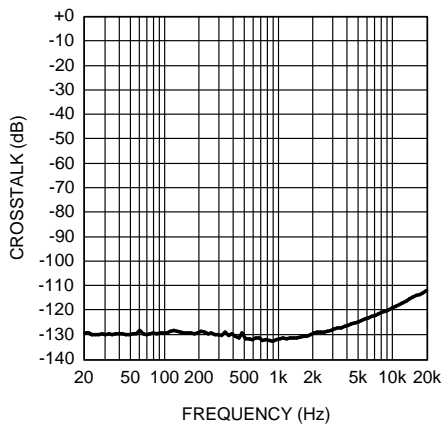


Figure 53. Crosstalk vs Frequency $V_{CC} = 12V$, $V_{EE} = -12V$, $V_{OUT} = 10V_{RMS}$ $A_V = 0dB$, $R_L = 10k\Omega$

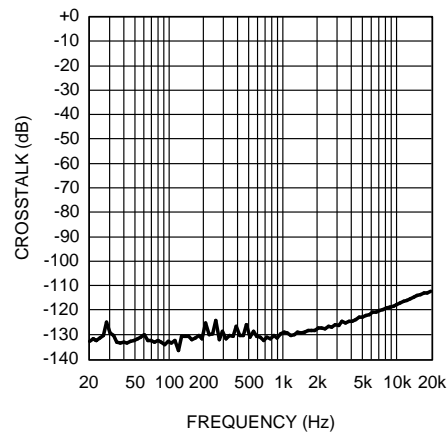


Figure 54. Crosstalk vs Frequency $V_{CC} = 17V$, $V_{EE} = -17V$, $V_{OUT} = 3V_{RMS}$ $A_V = 0dB$, $R_L = 10k\Omega$

Typical Characteristics (continued)

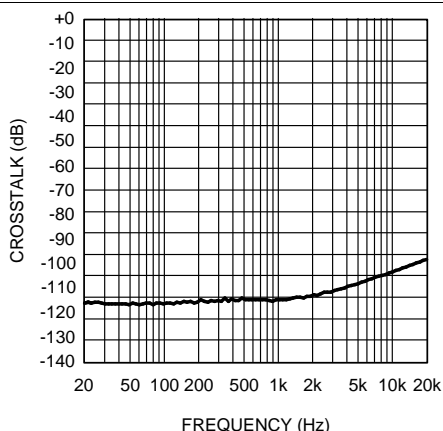


Figure 55. Crosstalk vs Frequency $V_{CC} = 17V$, $V_{EE} = -17V$, $V_{OUT} = 10V_{RMS}$ $A_V = 0dB$, $R_L = 10k\Omega$

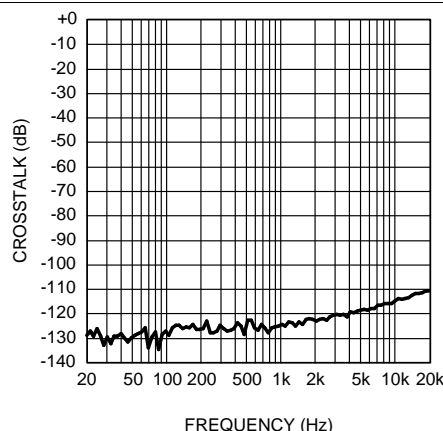


Figure 56. Crosstalk vs Frequency $V_{CC} = 2.5V$, $V_{EE} = -2.5V$, $V_{OUT} = 1V_{RMS}$ $A_V = 0dB$, $R_L = 10k\Omega$

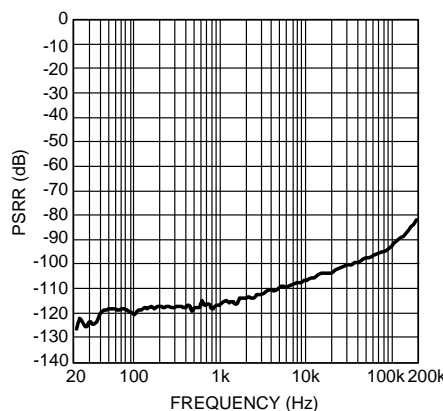


Figure 57. PSRR+ vs Frequency $V_{CC} = 15V$, $V_{EE} = -15V$ $R_L = 10k\Omega$, $F = 200kHz$, $V_{RIPPLE} = 200mvpp$

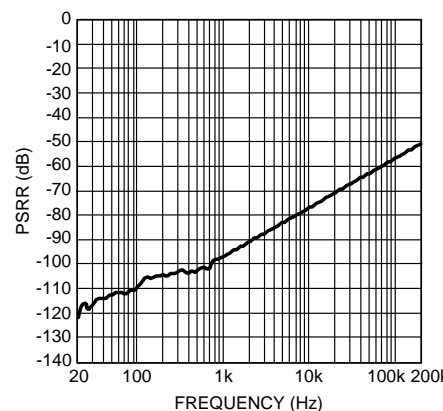


Figure 58. PSRR- vs Frequency $V_{CC} = 15V$, $V_{EE} = -15V$ $R_L = 10k\Omega$, $F = 200kHz$, $V_{RIPPLE} = 200mvpp$

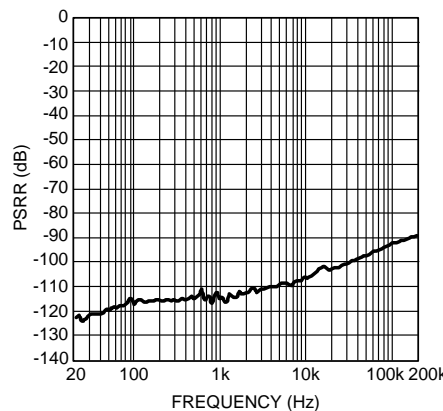


Figure 59. PSRR+ vs Frequency $V_{CC} = 15V$, $V_{EE} = -15V$ $R_L = 2k\Omega$, $F = 200kHz$, $V_{RIPPLE} = 200mvpp$

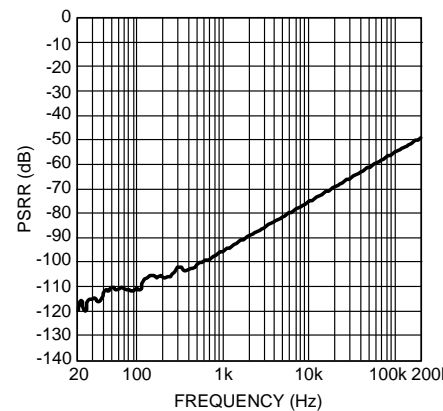


Figure 60. PSRR- vs Frequency $V_{CC} = 15V$, $V_{EE} = -15V$ $R_L = 2k\Omega$, $F = 200kHz$, $V_{RIPPLE} = 200mvpp$

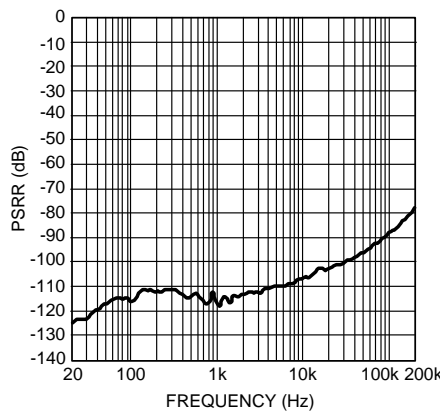
Typical Characteristics (continued)


Figure 61. PSRR+ vs Frequency $V_{CC} = 15V$, $V_{EE} = -15V$ $R_L = 600\Omega$, $F = 200kHz$, $V_{RIPPLE} = 200mvpp$

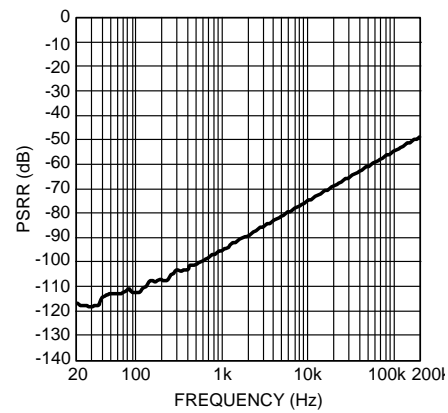


Figure 62. PSRR- vs Frequency $V_{CC} = 15V$, $V_{EE} = -15V$ $R_L = 600\Omega$, $F = 200kHz$, $V_{RIPPLE} = 200mvpp$

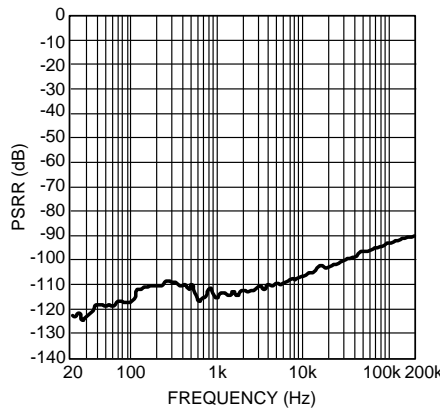


Figure 63. PSRR+ vs Frequency $V_{CC} = 12V$, $V_{EE} = -12V$ $R_L = 10k\Omega$, $F = 200kHz$, $V_{RIPPLE} = 200mvpp$

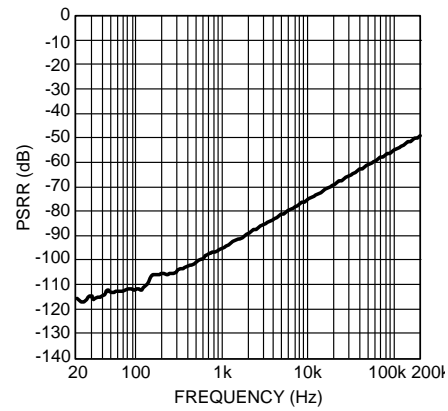


Figure 64. PSRR- vs Frequency $V_{CC} = 12V$, $V_{EE} = -12V$ $R_L = 10k\Omega$, $F = 200kHz$, $V_{RIPPLE} = 200mvpp$

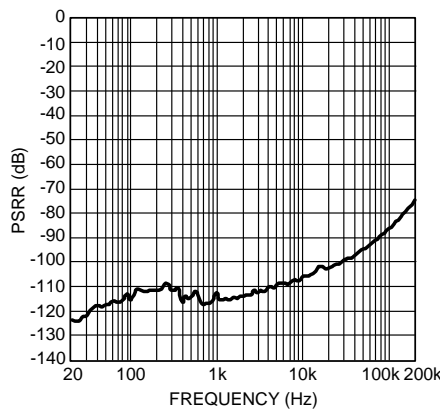


Figure 65. PSRR+ vs Frequency $V_{CC} = 12V$, $V_{EE} = -12V$ $R_L = 2k\Omega$, $F = 200kHz$, $V_{RIPPLE} = 200mvpp$

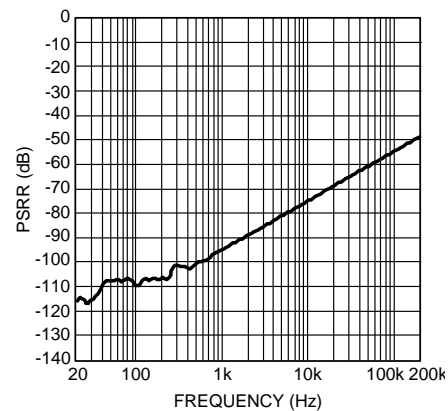


Figure 66. PSRR- vs Frequency $V_{CC} = 12V$, $V_{EE} = -12V$ $R_L = 2k\Omega$, $F = 200kHz$, $V_{RIPPLE} = 200mvpp$

Typical Characteristics (continued)

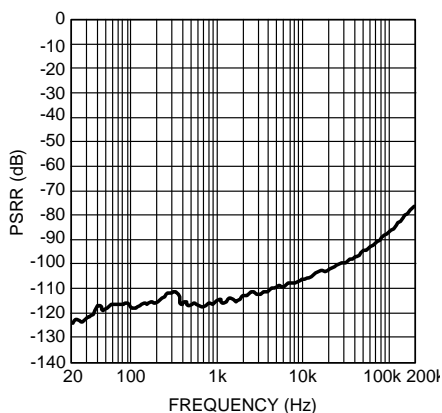


Figure 67. PSRR+ vs Frequency $V_{CC} = 12V$, $V_{EE} = -12V$ $R_L = 600\Omega$, $F = 200kHz$, $V_{RIPPLE} = 200mvpp$

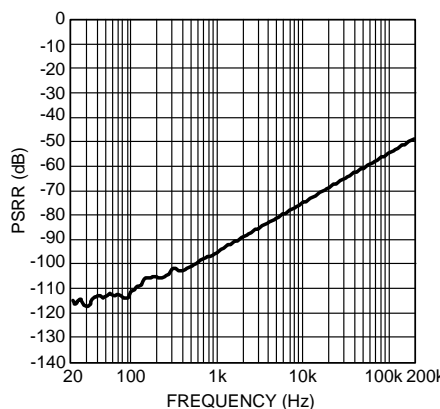


Figure 68. PSRR- vs Frequency $V_{CC} = 12V$, $V_{EE} = -12V$ $R_L = 600\Omega$, $F = 200kHz$, $V_{RIPPLE} = 200mvpp$

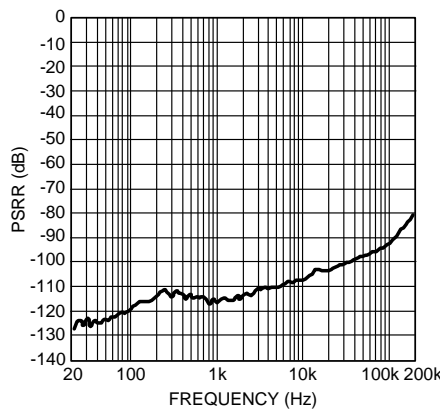


Figure 69. PSRR+ vs Frequency $V_{CC} = 17V$, $V_{EE} = -17V$ $R_L = 10k\Omega$, $F = 200kHz$, $V_{RIPPLE} = 200mvpp$

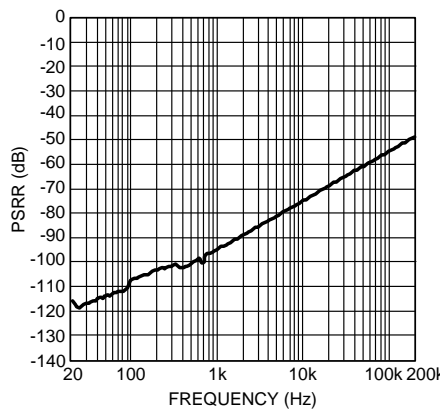


Figure 70. PSRR- vs Frequency $V_{CC} = 17V$, $V_{EE} = -17V$ $R_L = 10k\Omega$, $F = 200kHz$, $V_{RIPPLE} = 200mvpp$

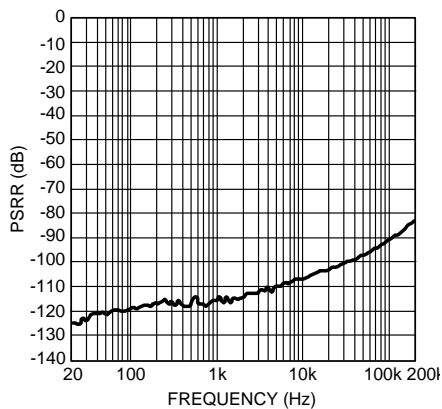


Figure 71. PSRR+ vs Frequency $V_{CC} = 17V$, $V_{EE} = -17V$ $R_L = 2k\Omega$, $F = 200kHz$, $V_{RIPPLE} = 200mvpp$

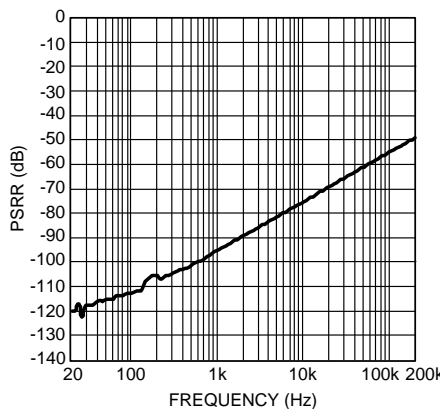
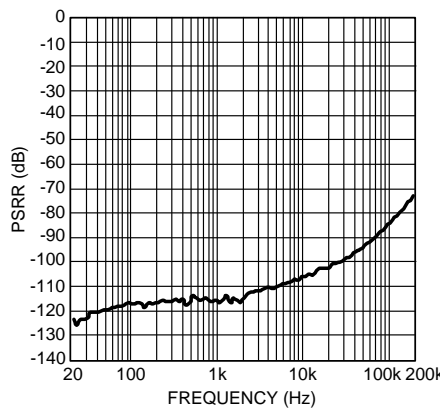
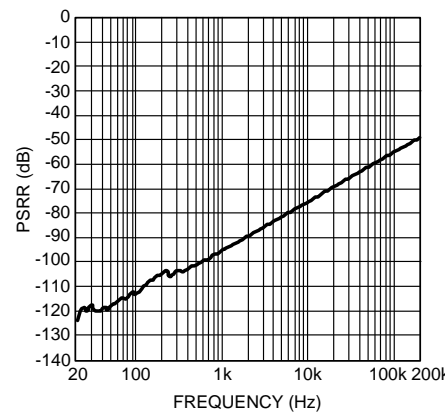
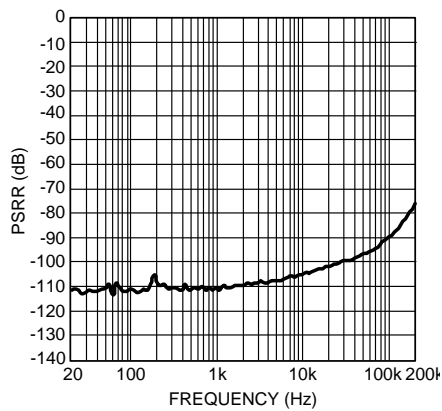
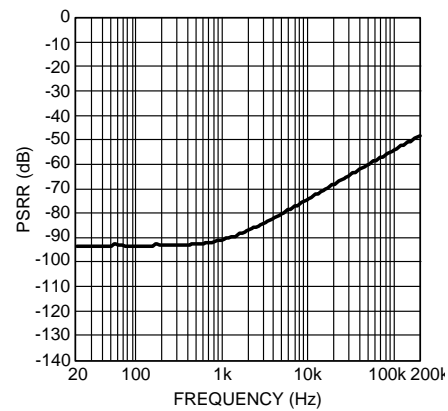
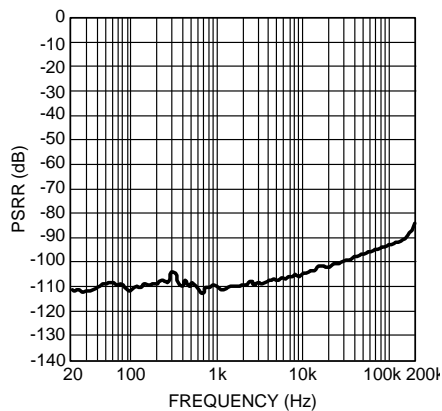
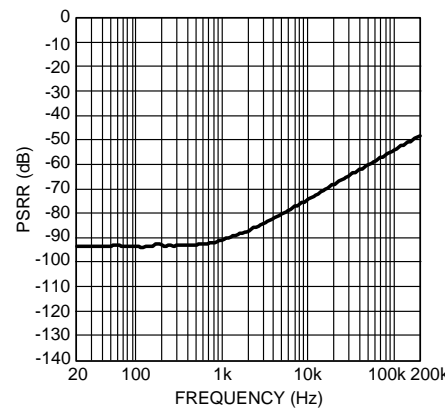


Figure 72. PSRR- vs Frequency $V_{CC} = 17V$, $V_{EE} = -17V$ $R_L = 2k\Omega$, $F = 200kHz$, $V_{RIPPLE} = 200mvpp$

Typical Characteristics (continued)

Figure 73. PSRR+ vs Frequency $V_{CC} = 17V$, $V_{EE} = -17V$ $R_L = 600\Omega$, $F = 200kHz$, $V_{RIPPLE} = 200mvpp$

Figure 74. PSRR- vs Frequency $V_{CC} = 17V$, $V_{EE} = -17V$ $R_L = 600\Omega$, $F = 200kHz$, $V_{RIPPLE} = 200mvpp$

Figure 75. PSRR+ vs Frequency $V_{CC} = 2.5V$, $V_{EE} = -2.5V$ $R_L = 10k\Omega$, $F = 200kHz$, $V_{RIPPLE} = 200mvpp$

Figure 76. PSRR- vs Frequency $V_{CC} = 2.5V$, $V_{EE} = -2.5V$ $R_L = 10k\Omega$, $F = 200kHz$, $V_{RIPPLE} = 200mvpp$

Figure 77. PSRR+ vs Frequency $V_{CC} = 2.5V$, $V_{EE} = -2.5V$ $R_L = 2k\Omega$, $F = 200kHz$, $V_{RIPPLE} = 200mvpp$

Figure 78. PSRR- vs Frequency $V_{CC} = 2.5V$, $V_{EE} = -2.5V$ $R_L = 2k\Omega$, $F = 200kHz$, $V_{RIPPLE} = 200mvpp$

Typical Characteristics (continued)

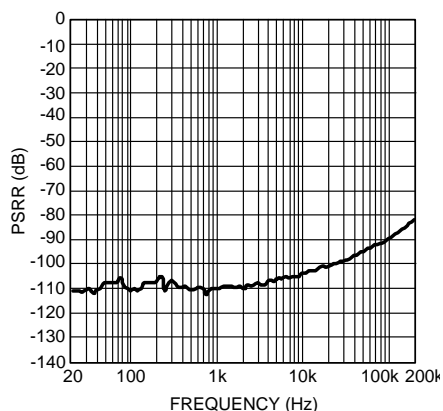


Figure 79. PSRR+ vs Frequency $V_{CC} = 2.5V$, $V_{EE} = -2.5V$ $R_L = 600\Omega$, $F = 200kHz$, $V_{RIPPLE} = 200mVpp$

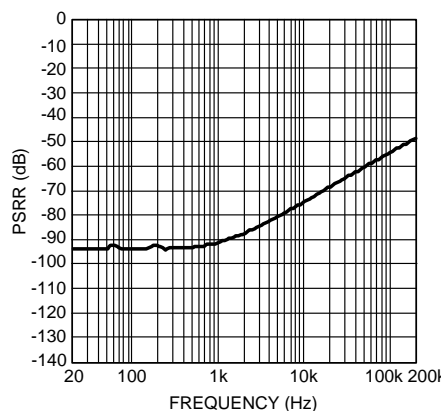


Figure 80. PSRR- vs Frequency $V_{CC} = 2.5V$, $V_{EE} = -2.5V$ $R_L = 600\Omega$, $F = 200kHz$, $V_{RIPPLE} = 200mVpp$

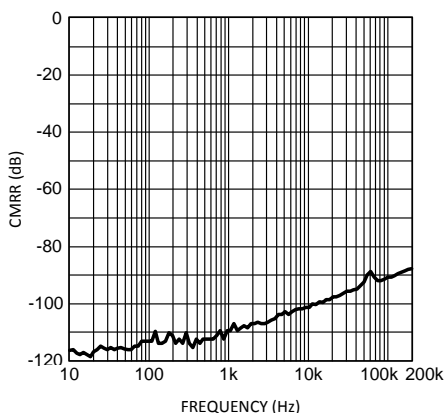


Figure 81. CMRR vs Frequency $V_{CC} = 15V$, $V_{EE} = -15V$ $R_L = 2k\Omega$

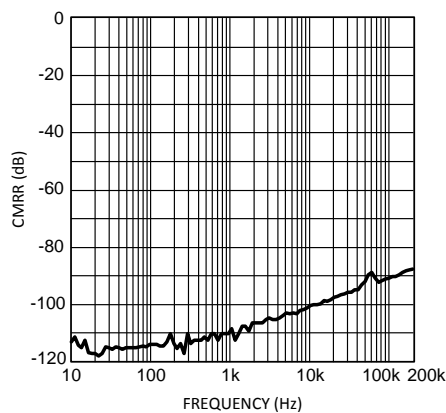


Figure 82. CMRR vs Frequency $V_{CC} = 12V$, $V_{EE} = -12V$ $R_L = 2k\Omega$

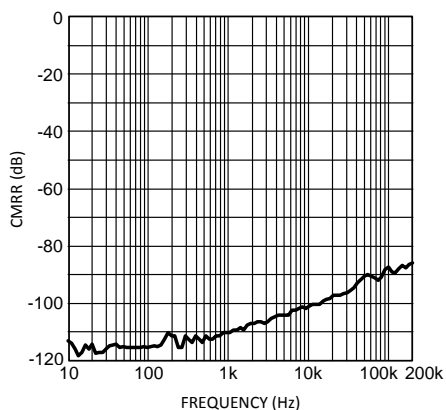


Figure 83. CMRR vs Frequency $V_{CC} = 17V$, $V_{EE} = -17V$ $R_L = 2k\Omega$

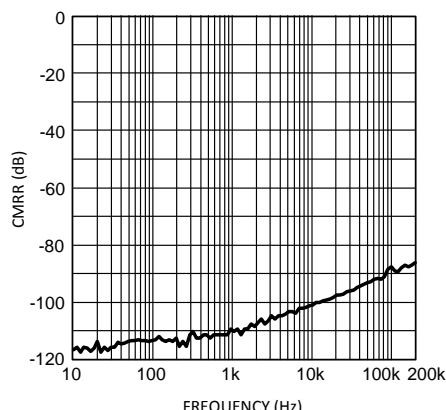
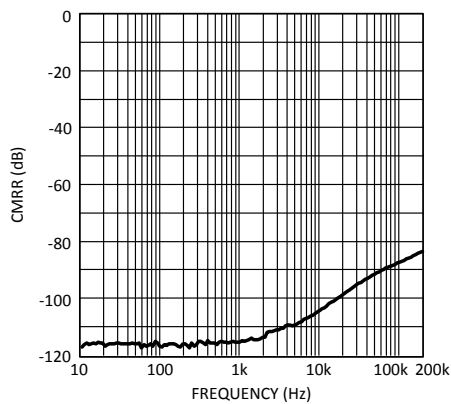
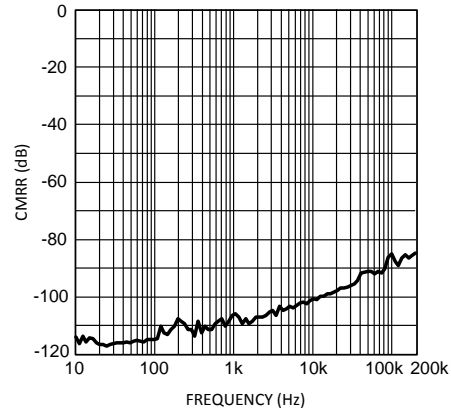
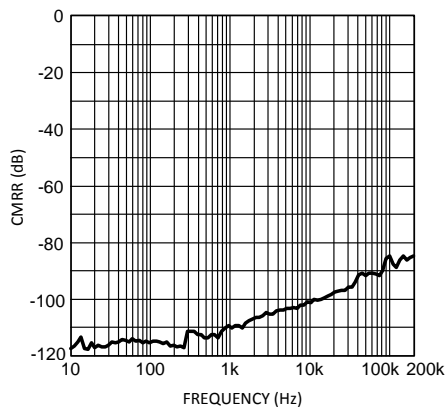
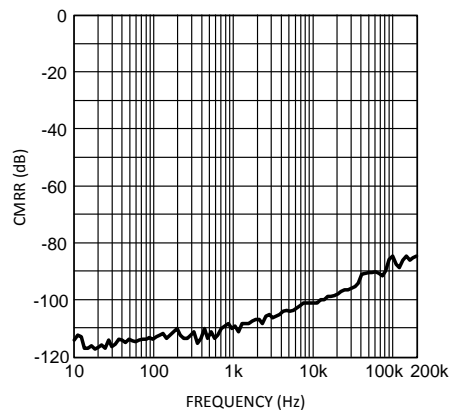
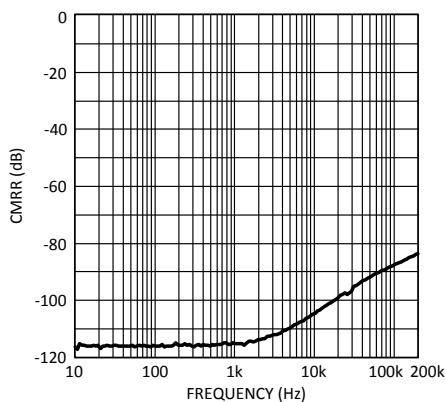
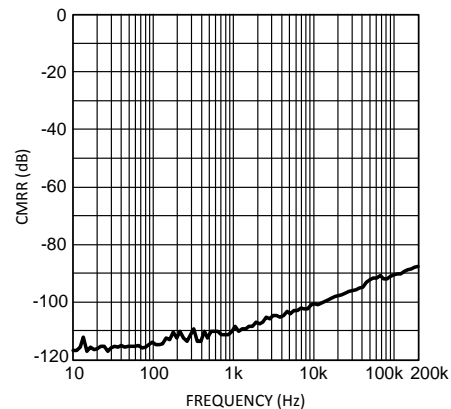


Figure 84. CMRR vs Frequency $V_{CC} = 2.5V$, $V_{EE} = -2.5V$ $R_L = 2k\Omega$

Typical Characteristics (continued)

Figure 85. Cmrr vs Frequency $V_{CC} = 15V$, $V_{EE} = -15V$ $R_L = 600\Omega$

Figure 86. Cmrr vs Frequency $V_{CC} = 12V$, $V_{EE} = -12V$ $R_L = 600\Omega$

Figure 87. Cmrr vs Frequency $V_{CC} = 17V$, $V_{EE} = -17V$ $R_L = 600\Omega$

Figure 88. Cmrr vs Frequency $V_{CC} = 2.5V$, $V_{EE} = -2.5V$ $R_L = 600\Omega$

Figure 89. Cmrr vs Frequency $V_{CC} = 15V$, $V_{EE} = -15V$ $R_L = 10k\Omega$

Figure 90. Cmrr vs Frequency $V_{CC} = 12V$, $V_{EE} = -12V$ $R_L = 10k\Omega$

Typical Characteristics (continued)

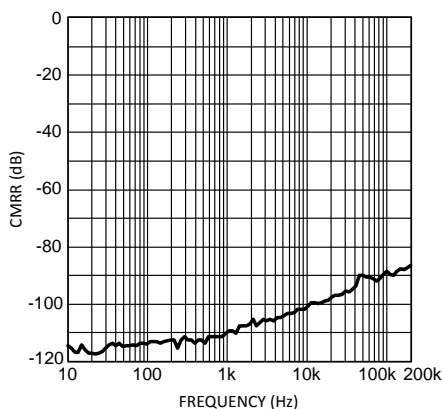


Figure 91. C_{mrr} vs Frequency $V_{CC} = 17V$, $V_{EE} = -17V$ $R_L = 10k\Omega$

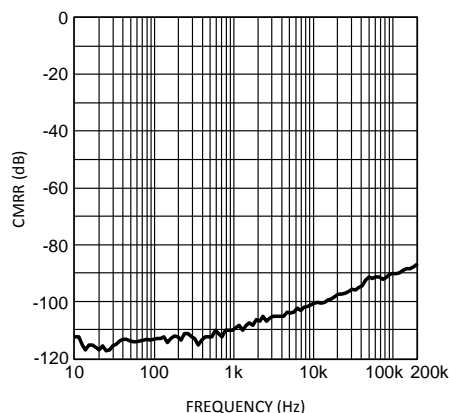


Figure 92. C_{mrr} vs Frequency $V_{CC} = 2.5V$, $V_{EE} = -2.5V$ $R_L = 10k\Omega$

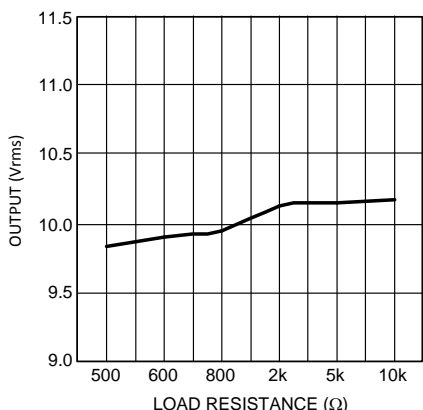


Figure 93. Output Voltage vs Load Resistance $V_{DD} = 15V$, $V_{EE} = -15V$ Thd+N = 1%

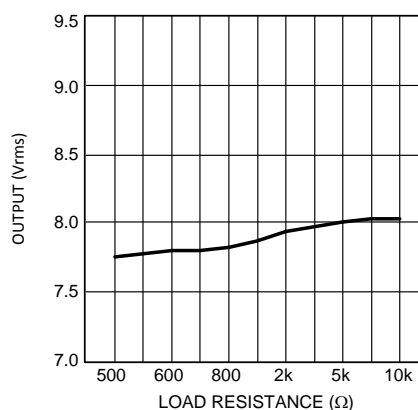


Figure 94. Output Voltage vs Load Resistance $V_{DD} = 12V$, $V_{EE} = -12V$ Thd+N = 1%

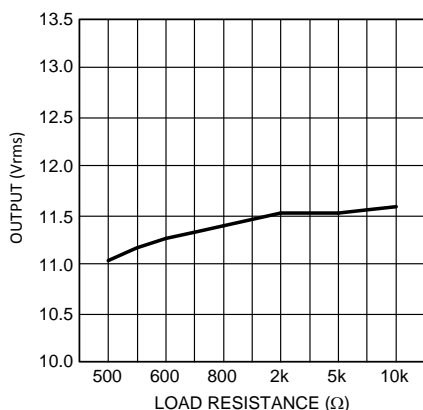


Figure 95. Output Voltage vs Load Resistance $V_{DD} = 17V$, $V_{EE} = -17V$ Thd+N = 1%

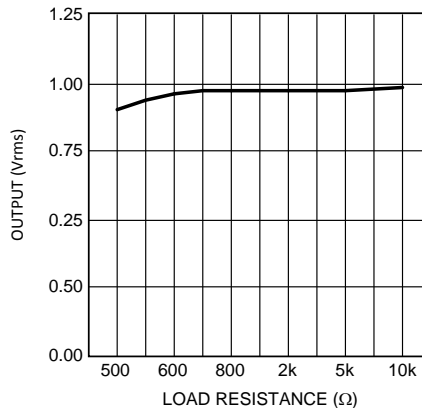
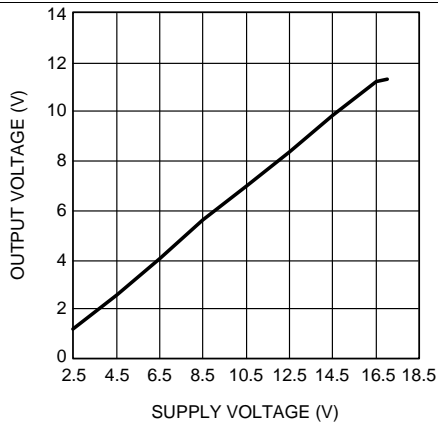
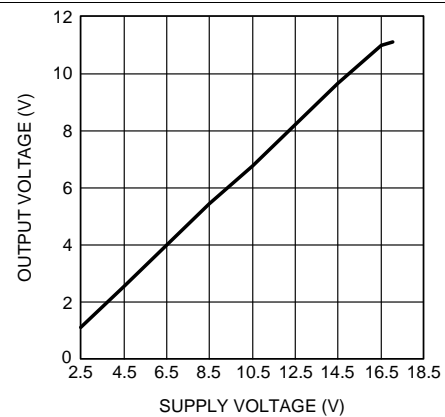
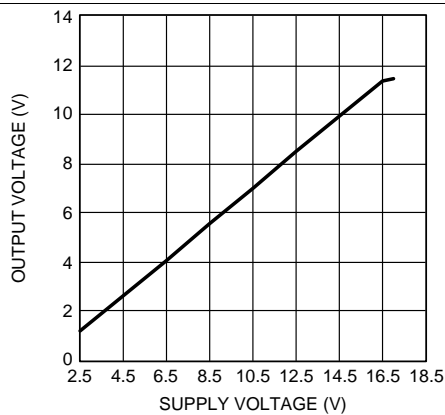
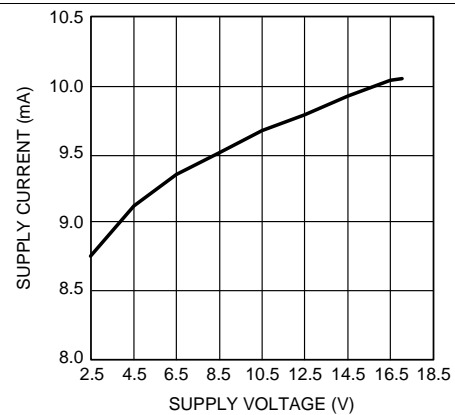
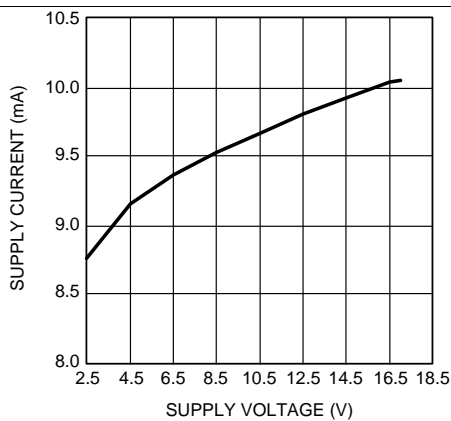
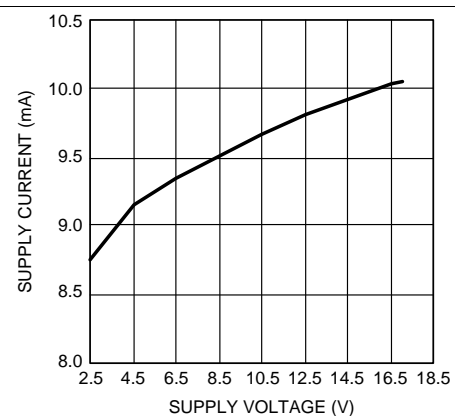


Figure 96. Output Voltage vs Load Resistance $V_{DD} = 2.5V$, $V_{EE} = -2.5V$ Thd+N = 1%

Typical Characteristics (continued)

Figure 97. Output Voltage vs Supply Voltage $R_L = 2k\Omega$, $T_{hd+N} = 1\%$

Figure 98. Output Voltage vs Supply Voltage $R_L = 600\Omega$, $T_{hd+N} = 1\%$

Figure 99. Output Voltage vs Supply Voltage $R_L = 10k\Omega$, $T_{hd+N} = 1\%$

Figure 100. Supply Current vs Supply Voltage $R_L = 2k\Omega$

Figure 101. Supply Current vs Supply Voltage $R_L = 600\Omega$

Figure 102. Supply Current vs Supply Voltage $R_L = 10k\Omega$

Typical Characteristics (continued)

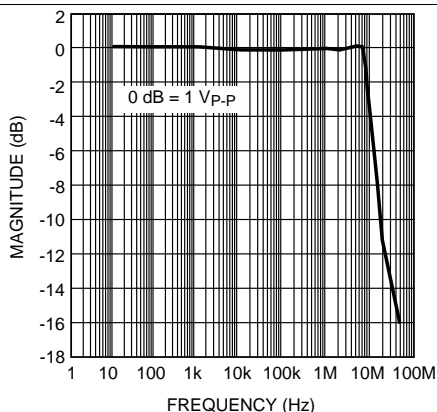


Figure 103. Full Power Bandwidth vs Frequency

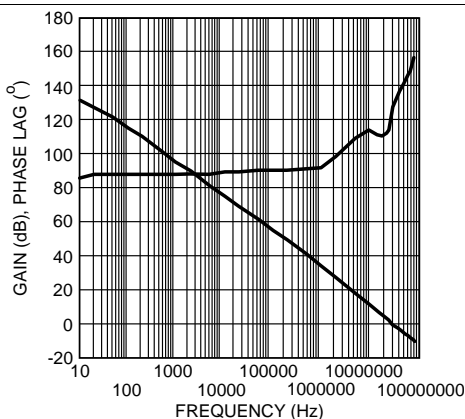


Figure 104. Gain Phase vs Frequency

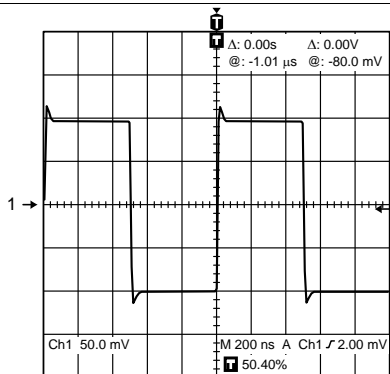


Figure 105. Small-Signal Transient Response $A_V = 1$, $C_L = 10\text{pf}$

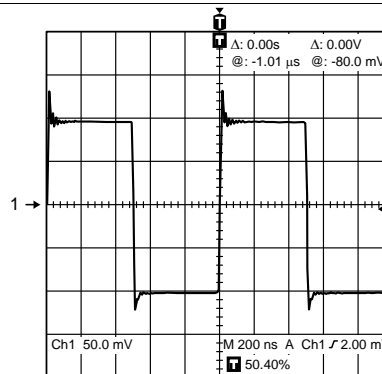


Figure 106. Small-Signal Transient Response $A_V = 1$, $C_L = 100\text{pf}$

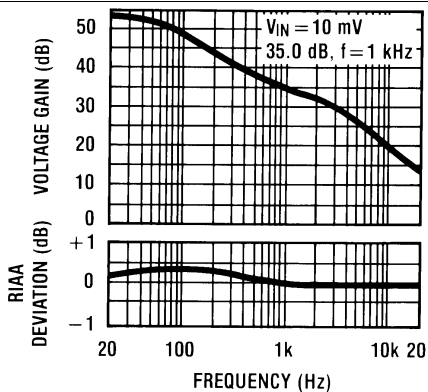


Figure 107. RIAA Preamp Voltage Gain, RIAA Deviation vs Frequency

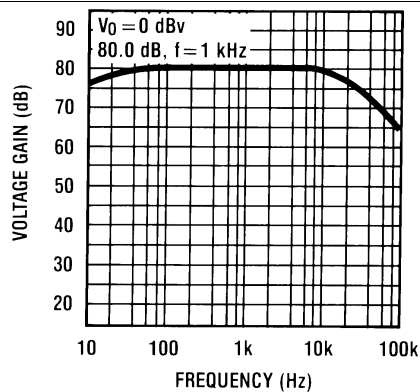


Figure 108. Flat Amp Voltage Gain vs Frequency

8 Parameter Measurement Information

All parameters are measured according to the conditions described in the [Specifications](#) section.

8.1 Distortion Measurements

The vanishingly low residual distortion produced by LME49720 is below the capabilities of all commercially available equipment. This makes distortion measurements just slightly more difficult than simply connecting a distortion meter to the amplifier's inputs and outputs. The solution, however, is quite simple: an additional resistor. Adding this resistor extends the resolution of the distortion measurement equipment.

The LME49720's low residual distortion is an input referred internal error. As shown in [Figure 109](#), adding the 10Ω resistor connected between the amplifier's inverting and non-inverting inputs changes the amplifier's noise gain. The result is that the error signal (distortion) is amplified by a factor of 101. Although the amplifier's closed-loop gain is unaltered, the feedback available to correct distortion errors is reduced by 101, which means that measurement resolution increases by 101. To ensure minimum effects on distortion measurements, keep the value of R1 low as shown in [Figure 109](#).

This technique is verified by duplicating the measurements with high closed loop gain and/or making the measurements at high frequencies. Doing so produces distortion components that are within the measurement equipment's capabilities. This datasheet's THD+N and IMD values were generated using the above described circuit connected to an Audio Precision System Two Cascade.

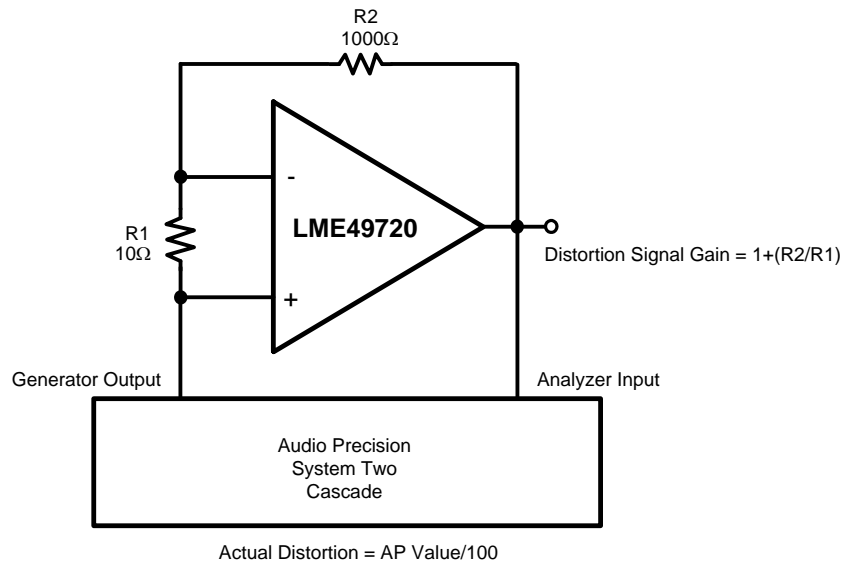
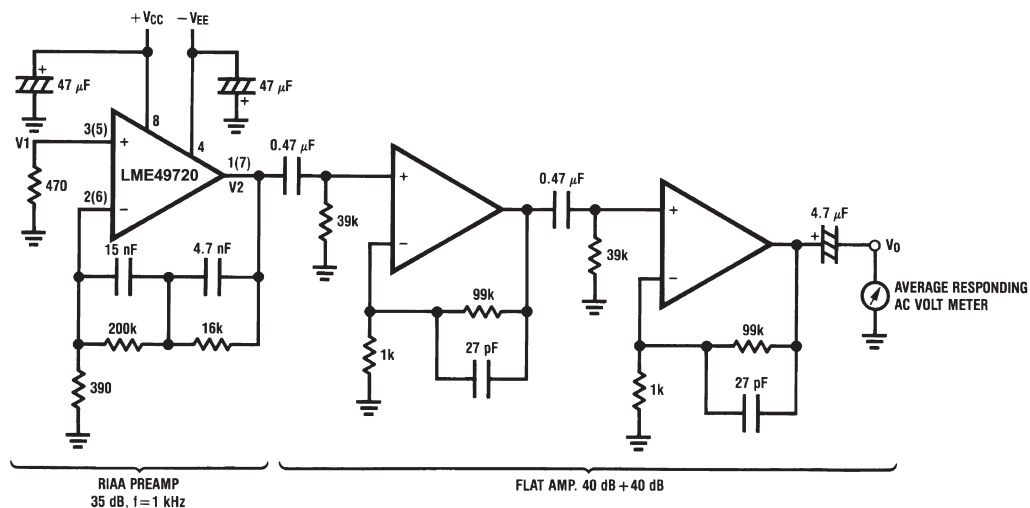


Figure 109. THD+N and IMD Distortion Test Circuit

Distortion Measurements (continued)



Complete shielding is required to prevent induced pick up from external sources. Always check with oscilloscope for power line noise.

Total Gain: 115 dB @ F = 1 kHz

Input Referred Noise Voltage: $E_n = V_0/560,000$ (V)

Figure 110. Noise Measurement Circuit

9 Detailed Description

9.1 Overview

The LME49720 audio operational amplifier delivers superior audio signal amplification for outstanding audio performance.

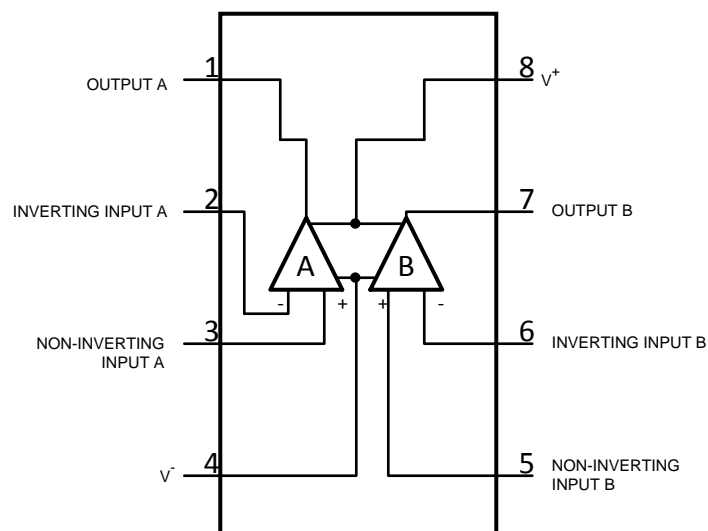
To ensure that the most challenging loads are driven without compromise, the LME49720 has a high slew rate of $\pm 20\text{V}/\mu\text{s}$ and an output current capability of $\pm 26\text{mA}$. Further, dynamic range is maximized by an output stage that drives $2\text{k}\Omega$ loads to within 1V of either power supply voltage and to within 1.4V when driving 600Ω loads.

The LME49720's outstanding CMRR (120dB), PSRR (120dB), and V_{OS} (0.1mV) give the amplifier excellent operational amplifier DC performance.

The LME49720 has a wide supply range of $\pm 2.5\text{V}$ to $\pm 17\text{V}$. Over this supply range the LME49720's input circuitry maintains excellent common-mode and power supply rejection, as well as maintaining its low input bias current. The LME49720 is unity gain stable. This Audio Operational Amplifier achieves outstanding AC performance while driving complex loads with values as high as 100pF .

The LME49720 is available in 8-lead narrow body SOIC, 8-lead PDIP, and 8-lead TO-99. Demonstration boards are available for each package.

9.2 Functional Block Diagram



9.3 Feature Description

9.3.1 Capacitive Load

The LME49720 is a high speed op amp with excellent phase margin and stability. Capacitive loads up to 100pF will cause little change in the phase characteristics of the amplifiers and are therefore allowable.

Capacitive loads greater than 100pF must be isolated from the output. The most straightforward way to do this is to put a resistor in series with the output. This resistor will also prevent excess power dissipation if the output is accidentally shorted.

9.3.2 Balance Cable Driver

With high peak-to-peak differential output voltage and plenty of low distortion drive current, the LME49720 makes an excellent balanced cable driver. Combining the single-to-differential configuration with a balanced cable driver results in a high performance single-ended input to balanced line driver solution.

Although the LME49720 can drive capacitive loads up to 100pF , cable loads exceeding 100pF can cause instability. For such applications, series resistors are needed on the outputs before the capacitive load.

9.4 Device Functional Modes

This device does not have operation mode.

10 Application and Implementation

NOTE

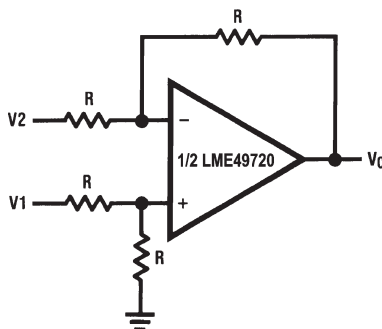
Information in the following applications sections is not part of the TI component specification, and TI does not warrant its accuracy or completeness. TI's customers are responsible for determining suitability of components for their purposes. Customers should validate and test their design implementation to confirm system functionality.

10.1 Application Information

These typical connection diagrams highlight the required external components and system level connections for proper operation of the device. Any design variation can be supported by TI through schematic and layout reviews. Visit e2e.ti.com for design assistance and join the audio amplifier discussion forum for additional information

10.2 Typical Applications

10.2.1 Single Ended Converter



$$V_O = V1 - V2$$

Figure 111. Balanced To Single Ended Converter

10.2.1.1 Design Requirements

For this design example, use the parameters listed in [Table 1](#).

Table 1. Design Parameters

| DESIGN PARAMETER | EXAMPLE VALUE |
|------------------|---------------|
| Power Supply | ±15 |
| Speaker | 2 KΩ |

10.2.1.2 Detailed Design Procedure

10.2.1.2.1 Surface Mount Capacitors

Temperature and applied DC voltage influence the actual capacitance of high-K materials. [Table 2](#) shows the relationship between the different types of high-K materials and their associated tolerances, temperature coefficients, and temperature ranges. Notice that a capacitor made with X5R material can lose up to 15% of its capacitance within its working temperature range.

Select high-K ceramic capacitors according to the following rules:

1. Use capacitors made of materials with temperature coefficients of X5R, X7R, or better.
2. Use capacitors with DC voltage ratings of at least twice the application voltage.
3. Choose a capacitance value at least twice the nominal value calculated for the application.

Multiply the nominal value by a factor of 2 for safety. If a 10- μ F capacitor is required, use 20 μ F.

The preceding rules and recommendations apply to capacitors used in connection with this device. The LME49720 cannot meet its performance specifications if the rules and recommendations are not followed.

Table 2. Typical Tolerance and Temperature Coefficient of Capacitance by Material

| Material | COG/NPO | X7R | X5R |
|-----------------------|--------------|------------|-----------|
| Typical Tolerance | $\pm 5\%$ | $\pm 10\%$ | 80/–20% |
| Temperature | ± 30 ppm | $\pm 15\%$ | 22/–82% |
| Temperature Range, °C | –55/125°C | –55/125°C | –30/85 °C |

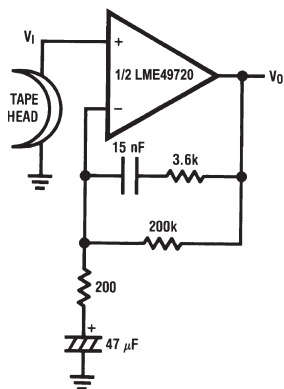
10.2.1.3 Application Curves

For application curves, see the figures listed in [Table 3](#).

Table 3. Table of Graphs

| DESCRIPTION | FIGURE NUMBER |
|------------------------|-------------------------------|
| THD+N vs Output Power | See Figure 1 |
| THD+N vs Frequency | See Figure 13 |
| Crosstalk vs Frequency | See Figure 36 |
| PSRR vs Frequency | See Figure 58 |

10.2.2 Other Applications



$A_V = 34.5$
 $F = 1 \text{ kHz}$
 $E_n = 0.38 \mu\text{V}$
 A Weighted

Figure 112. Nab Preamp

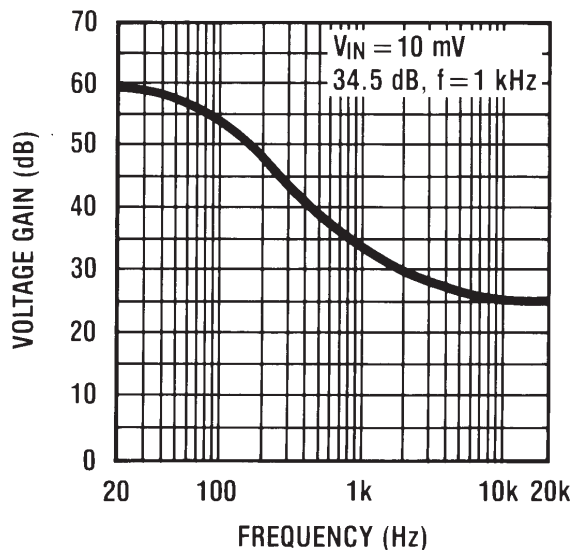
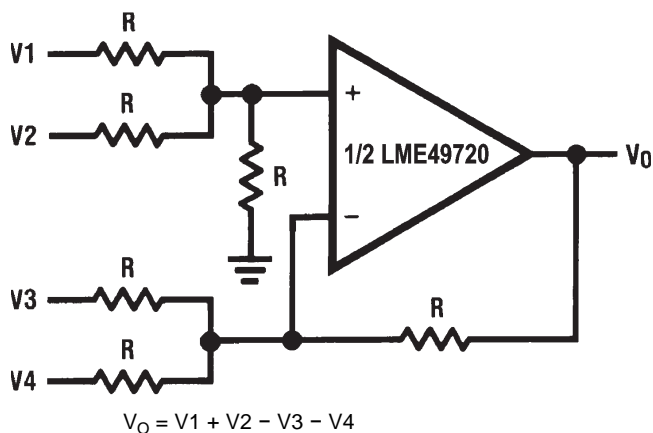
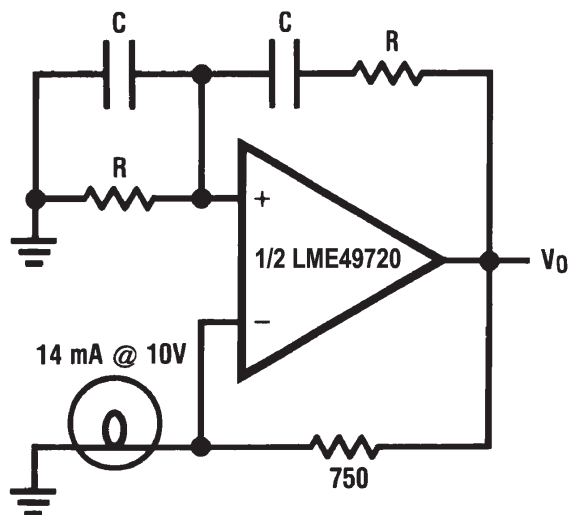


Figure 113. Nab Preamp Voltage Gain vs Frequency



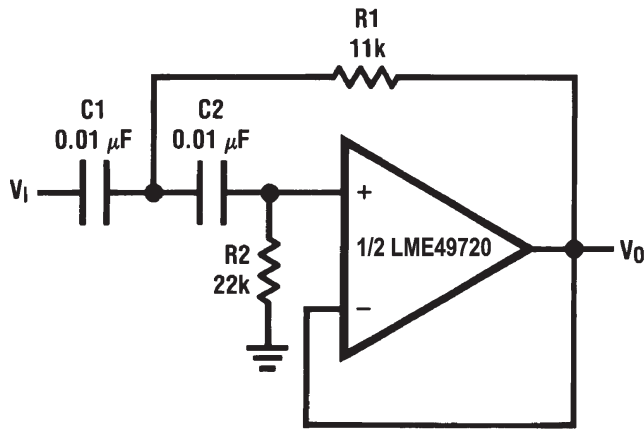
$$V_O = V_1 + V_2 - V_3 - V_4$$

Figure 114. Adder/Subtractor



$$f_o = \frac{1}{2\pi RC}$$

Figure 115. Sine Wave Oscillator



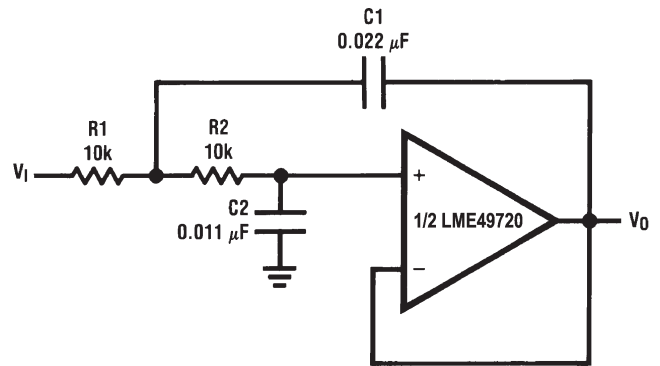
if $C1 = C2 = C$

$$R1 = \frac{\sqrt{2}}{2\omega_0 C}$$

$$R2 = 2 \times R1$$

Illustration is $f_0 = 1 \text{ kHz}$

Figure 116. Second Order High Pass Filter (Butterworth)



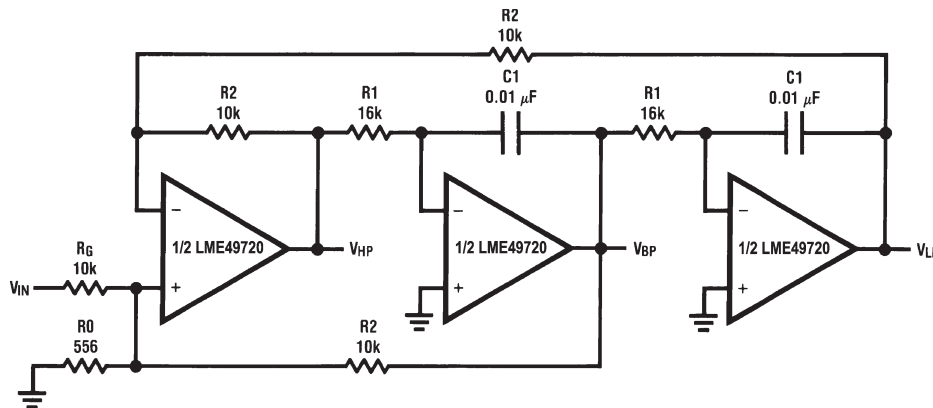
if $R1 = R2 = R$

$$C1 = \frac{\sqrt{2}}{\omega_0 R}$$

$$C2 = \frac{C1}{2}$$

Illustration is $f_0 = 1 \text{ kHz}$

Figure 117. Second Order Low Pass Filter (Butterworth)



$$f_0 = \frac{1}{2\pi C1 R1}, Q = \frac{1}{2} \left(1 + \frac{R2}{R0} + \frac{R2}{RG} \right), A_{BP} = QA_{LP} = QA_{LH} = \frac{R2}{RG}$$

Illustration is $f_0 = 1 \text{ kHz}$, $Q = 10$, $A_{BP} = 1$

Figure 118. State Variable Filter

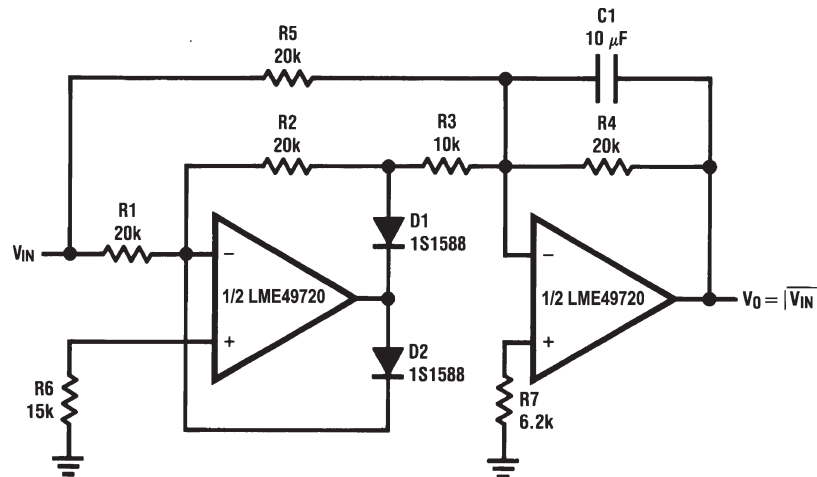


Figure 119. AC/DC Converter

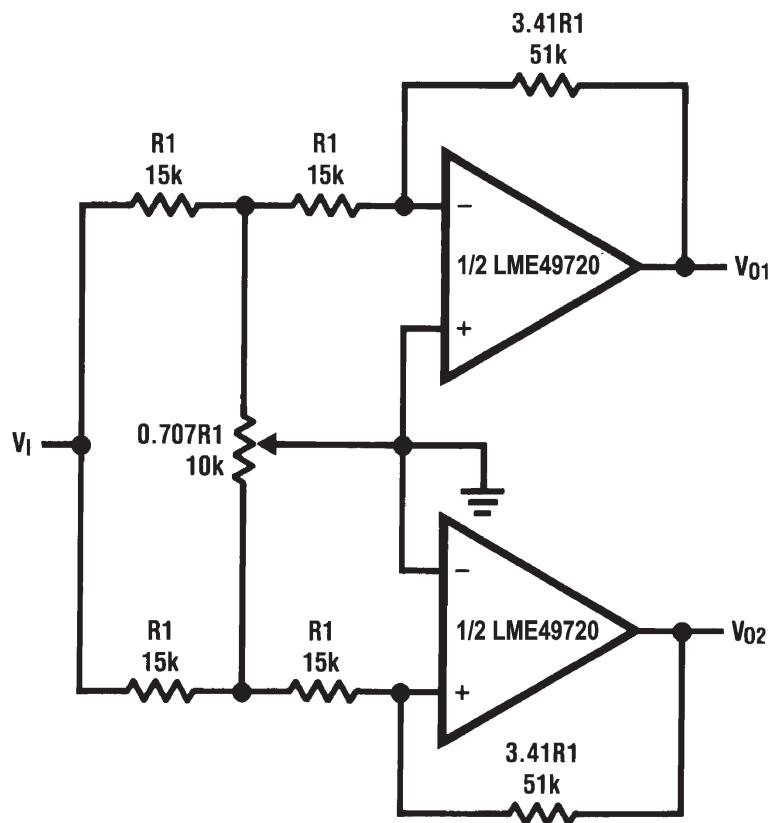


Figure 120. 2 Channel Panning Circuit (Pan Pot)

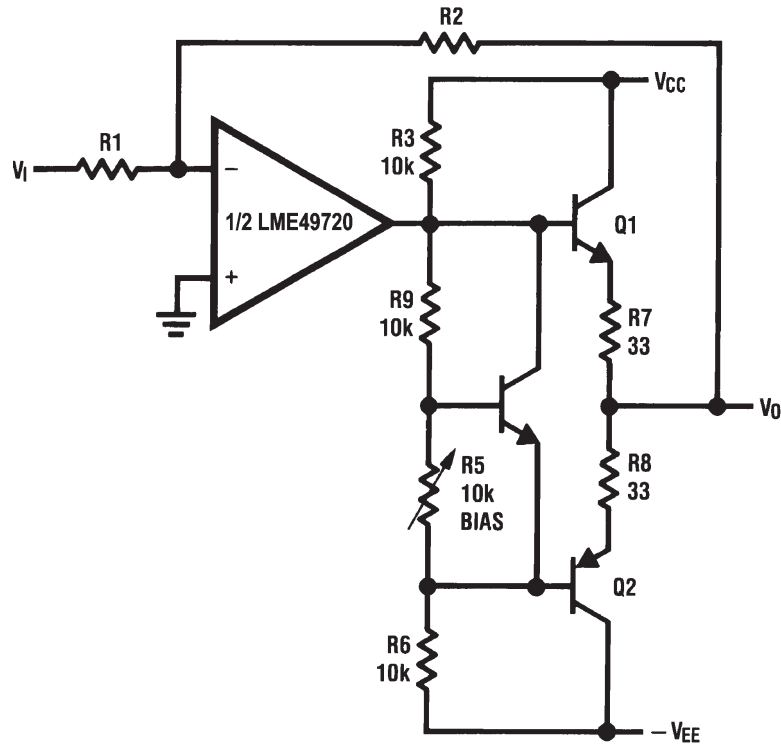
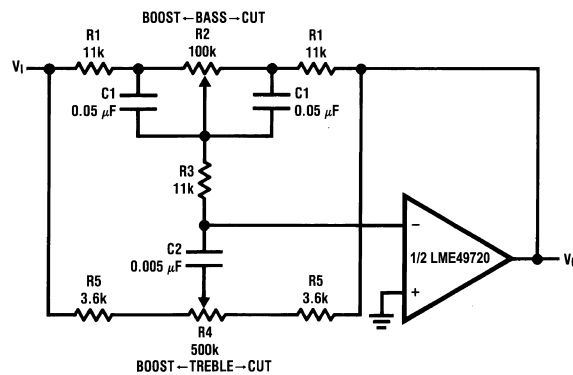


Figure 121. Line Driver



$$f_L = \frac{1}{2\pi R_2 C_1}, f_{LB} = \frac{1}{2\pi R_1 C_1}$$

$$f_H = \frac{1}{2\pi R_5 C_2}, f_{HB} = \frac{1}{2\pi (R_1 + R_5 + 2R_3) C_2}$$

Illustration is:

$$f_L = 32 \text{ Hz}, f_{LB} = 320 \text{ Hz}$$

$$f_H = 11 \text{ kHz}, f_{HB} = 1.1 \text{ kHz}$$

Figure 122. Tone Control

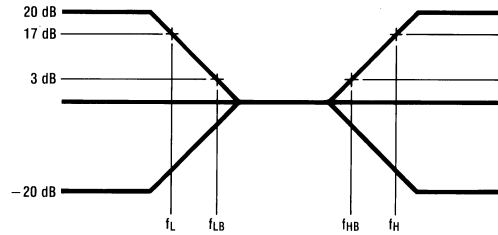
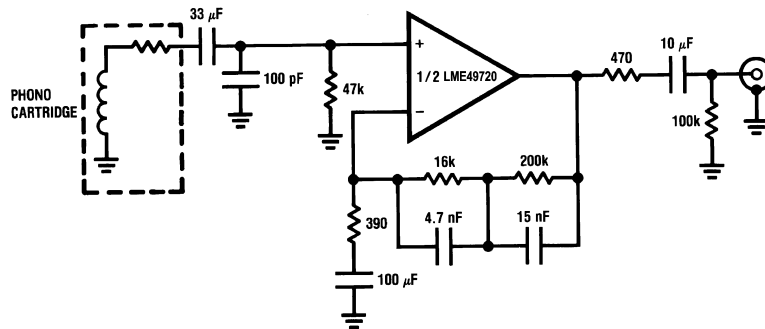
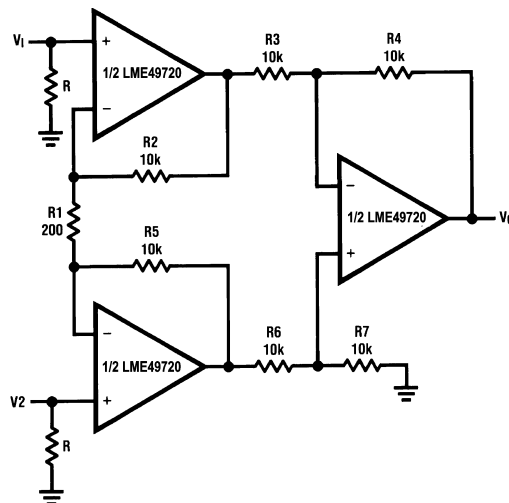


Figure 123. RIAA Preamp Behavior



$A_v = 35 \text{ dB}$
 $E_n = 0.33 \mu\text{V}$
 $S/N = 90 \text{ dB}$
 $f = 1 \text{ kHz}$
 A Weighted
 A Weighted, $V_{IN} = 10 \text{ mV}$
 @ $f = 1 \text{ kHz}$

Figure 124. RIAA Preamp

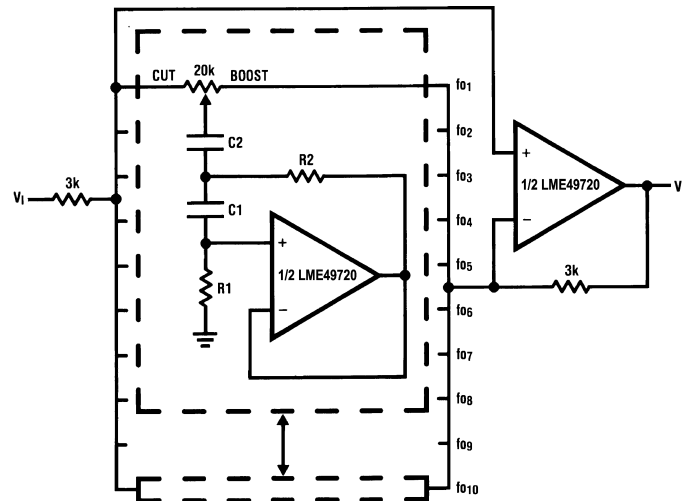


If $R2 = R5, R3 = R6, R4 = R7$

$$V_0 = \left(1 + \frac{2R2}{R1}\right) \frac{R4}{R3} (V2 - V1)$$
 Illustration is:

$$V_0 = 101(V2 - V1)$$

Figure 125. Balanced Input Mic Amp


Figure 126. 10 Band Graphic Equalizer
Table 4. Typical Values for Band Graphic Equalizer

| fo (Hz) | C ₁ | C ₂ | R ₁ | R ₂ |
|---------|----------------|----------------|----------------|----------------|
| 32 | 0.12 μ F | 4.7 μ F | 75k Ω | 500 Ω |
| 64 | 0.056 μ F | 3.3 μ F | 68k Ω | 510 Ω |
| 125 | 0.033 μ F | 1.5 μ F | 62k Ω | 510 Ω |
| 250 | 0.015 μ F | 0.82 μ F | 68k Ω | 470 Ω |
| 500 | 8200pF | 0.39 μ F | 62k Ω | 470 Ω |
| 1k | 3900pF | 0.22 μ F | 68k Ω | 470 Ω |
| 2k | 2000pF | 0.1 μ F | 68k Ω | 470 Ω |
| 4k | 1100pF | 0.056 μ F | 62k Ω | 470 Ω |
| 8k | 510pF | 0.022 μ F | 68k Ω | 510 Ω |
| 16k | 330pF | 0.012 μ F | 51k Ω | 510 Ω |

11 Power Supply Recommendations

The LME49720 is designed to operate a power supply from $\pm 2.5\text{V}$ to $\pm 17\text{V}$. Therefore, the output voltage range of the power supply must be within this range. The current capability of upper power must not exceed the maximum current limit of the power switch.

11.1 Power Supply Decoupling Capacitors

The LME49720 requires adequate power supply decoupling to ensure a low total harmonic distortion (THD). Place a low equivalent-series-resistance (ESR) ceramic capacitor, typically $0.1\ \mu\text{F}$, within 2 mm of the V+ and V- pins. This choice of capacitor and placement helps with higher frequency transients, spikes, or digital hash on the line. In addition to the $0.1\ \mu\text{F}$ ceramic capacitor, it is recommended to place a $2.2\ \mu\text{F}$ to $10\ \mu\text{F}$ capacitor on the V+ and V- pins. This larger capacitor acts as a charge reservoir, providing energy faster than the board supply, thus helping to prevent any droop in the supply voltage.

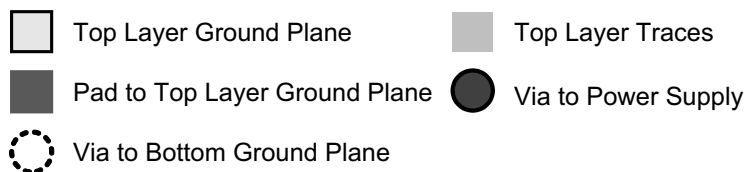
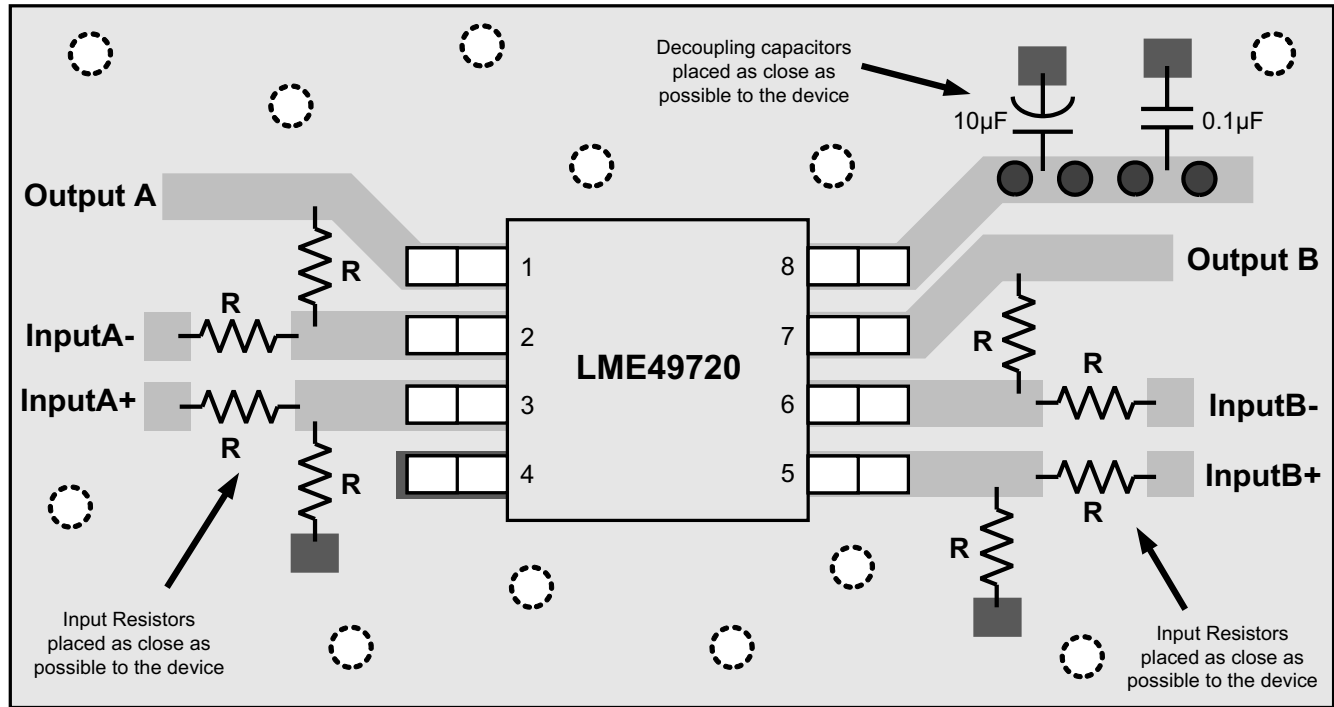
12 Layout

12.1 Layout Guidelines

12.1.1 Component Placement

Place all the external components close to the device. Placing the decoupling capacitors as close as possible to the device is important for low total harmonic distortion (THD). Any resistance or inductance in the trace between the device and the capacitor can cause a loss in efficiency.

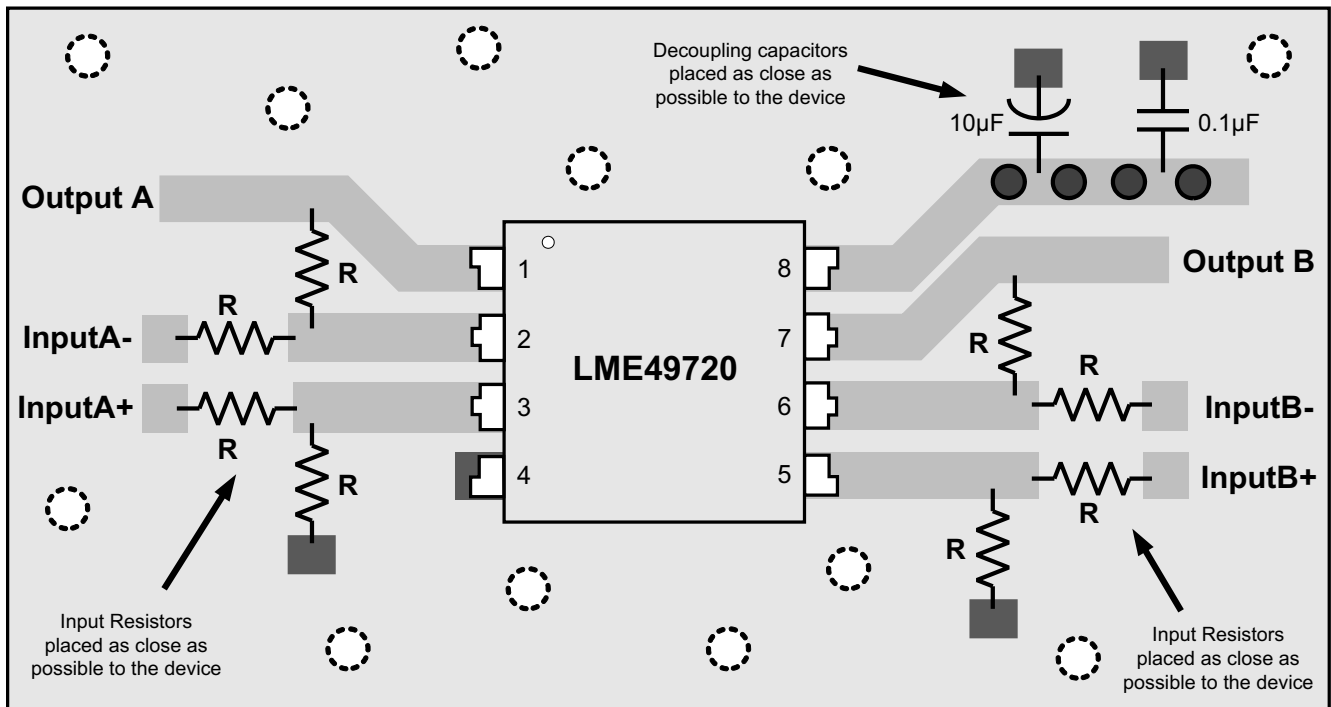
12.2 Layout Example



Copyright © 2016, Texas Instruments Incorporated

Figure 127. LME49720SOIC Layout Example

Layout Example (continued)

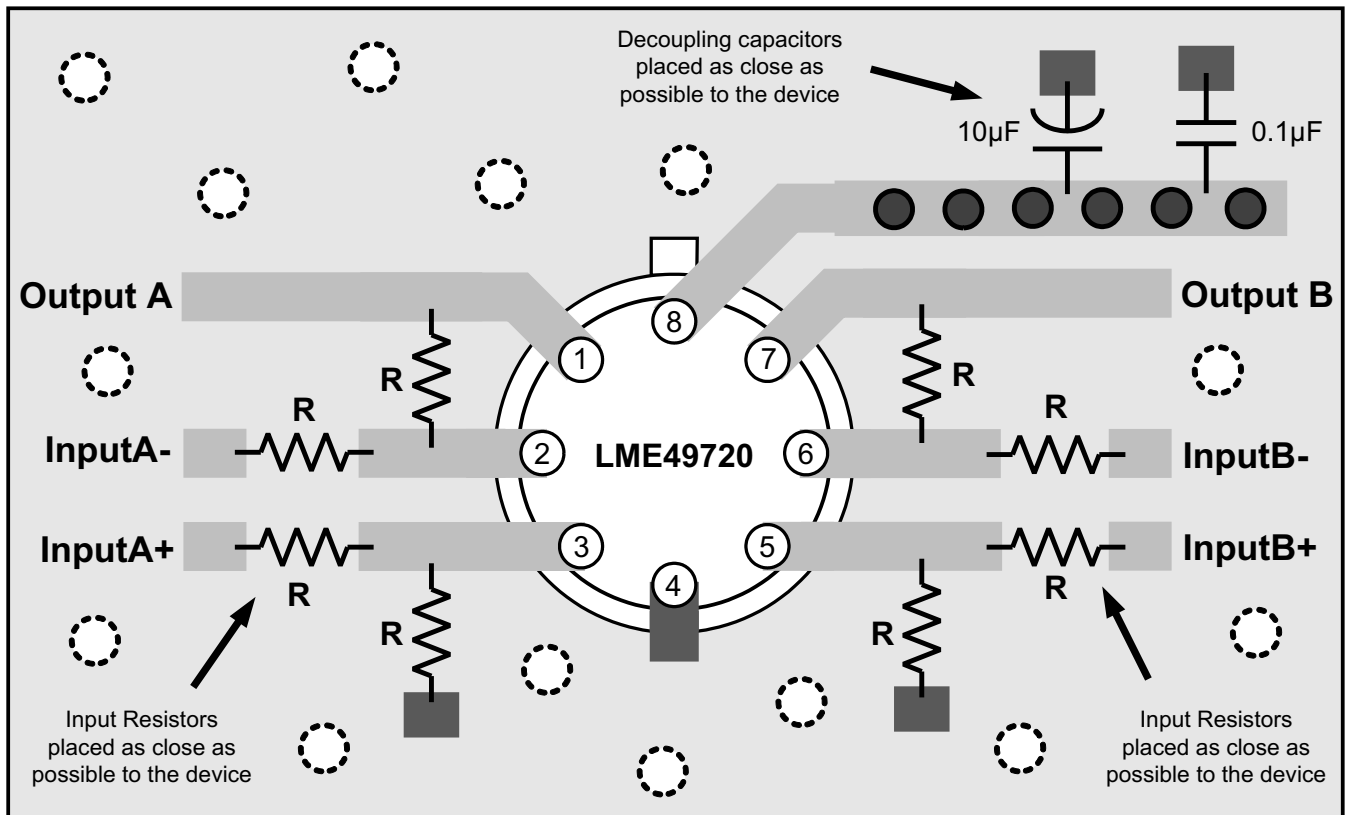


- Top Layer Ground Plane
- Top Layer Traces
- Pad to Top Layer Ground Plane
- Via to Power Supply
- Via to Bottom Ground Plane

Copyright © 2016, Texas Instruments Incorporated

Figure 128. LME49720PDIP Layout Example

Layout Example (continued)



- Top Layer Ground Plane
- Top Layer Traces
- Pad to Top Layer Ground Plane
- Via to Power Supply
- Via to Bottom Ground Plane

Copyright © 2016, Texas Instruments Incorporated

Figure 129. LME49720TO-99 Layout Example

13 Device and Documentation Support

13.1 Receiving Notification of Documentation Updates

To receive notification of documentation updates, navigate to the device product folder on ti.com. In the upper right corner, click on *Alert me* to register and receive a weekly digest of any product information that has changed. For change details, review the revision history included in any revised document.

13.2 Community Resources

The following links connect to TI community resources. Linked contents are provided "AS IS" by the respective contributors. They do not constitute TI specifications and do not necessarily reflect TI's views; see TI's [Terms of Use](#).

TI E2E™ Online Community *TI's Engineer-to-Engineer (E2E) Community*. Created to foster collaboration among engineers. At e2e.ti.com, you can ask questions, share knowledge, explore ideas and help solve problems with fellow engineers.

Design Support *TI's Design Support* Quickly find helpful E2E forums along with design support tools and contact information for technical support.

13.3 Trademarks

E2E is a trademark of Texas Instruments.
All other trademarks are the property of their respective owners.

13.4 Electrostatic Discharge Caution



This integrated circuit can be damaged by ESD. Texas Instruments recommends that all integrated circuits be handled with appropriate precautions. Failure to observe proper handling and installation procedures can cause damage.

ESD damage can range from subtle performance degradation to complete device failure. Precision integrated circuits may be more susceptible to damage because very small parametric changes could cause the device not to meet its published specifications.

13.5 Glossary

[SLYZ022](#) — *TI Glossary*.

This glossary lists and explains terms, acronyms, and definitions.

14 Mechanical, Packaging, and Orderable Information

The following pages include mechanical, packaging, and orderable information. This information is the most current data available for the designated devices. This data is subject to change without notice and revision of this document. For browser-based versions of this data sheet, refer to the left-hand navigation.

PACKAGING INFORMATION

| Orderable Device | Status (1) | Package Type | Package Drawing | Pins | Package Qty | Eco Plan (2) | Lead finish/ Ball material (6) | MSL Peak Temp (3) | Op Temp (°C) | Device Marking (4/5) | Samples |
|------------------|---------------|--------------|-----------------|------|-------------|-----------------|--------------------------------------|----------------------|--------------|-------------------------|-------------------------|
| LME49720MAX/NOPB | ACTIVE | SOIC | D | 8 | 2500 | RoHS & Green | SN | Level-1-260C-UNLIM | -40 to 85 | L49720 MA | Samples |
| LME49720NA/NOPB | ACTIVE | PDIP | P | 8 | 40 | RoHS & Green | NIPDAU | Level-1-NA-UNLIM | -40 to 85 | LME 49720NA | Samples |

(1) The marketing status values are defined as follows:

ACTIVE: Product device recommended for new designs.

LIFEBUY: TI has announced that the device will be discontinued, and a lifetime-buy period is in effect.

NRND: Not recommended for new designs. Device is in production to support existing customers, but TI does not recommend using this part in a new design.

PREVIEW: Device has been announced but is not in production. Samples may or may not be available.

OBSOLETE: TI has discontinued the production of the device.

(2) **RoHS:** TI defines "RoHS" to mean semiconductor products that are compliant with the current EU RoHS requirements for all 10 RoHS substances, including the requirement that RoHS substance do not exceed 0.1% by weight in homogeneous materials. Where designed to be soldered at high temperatures, "RoHS" products are suitable for use in specified lead-free processes. TI may reference these types of products as "Pb-Free".

RoHS Exempt: TI defines "RoHS Exempt" to mean products that contain lead but are compliant with EU RoHS pursuant to a specific EU RoHS exemption.

Green: TI defines "Green" to mean the content of Chlorine (Cl) and Bromine (Br) based flame retardants meet JS709B low halogen requirements of <=1000ppm threshold. Antimony trioxide based flame retardants must also meet the <=1000ppm threshold requirement.

(3) MSL, Peak Temp. - The Moisture Sensitivity Level rating according to the JEDEC industry standard classifications, and peak solder temperature.

(4) There may be additional marking, which relates to the logo, the lot trace code information, or the environmental category on the device.

(5) Multiple Device Markings will be inside parentheses. Only one Device Marking contained in parentheses and separated by a "~" will appear on a device. If a line is indented then it is a continuation of the previous line and the two combined represent the entire Device Marking for that device.

(6) Lead finish/Ball material - Orderable Devices may have multiple material finish options. Finish options are separated by a vertical ruled line. Lead finish/Ball material values may wrap to two lines if the finish value exceeds the maximum column width.

Important Information and Disclaimer:The information provided on this page represents TI's knowledge and belief as of the date that it is provided. TI bases its knowledge and belief on information provided by third parties, and makes no representation or warranty as to the accuracy of such information. Efforts are underway to better integrate information from third parties. TI has taken and continues to take reasonable steps to provide representative and accurate information but may not have conducted destructive testing or chemical analysis on incoming materials and chemicals. TI and TI suppliers consider certain information to be proprietary, and thus CAS numbers and other limited information may not be available for release.

In no event shall TI's liability arising out of such information exceed the total purchase price of the TI part(s) at issue in this document sold by TI to Customer on an annual basis.

TAPE AND REEL INFORMATION

QUADRANT ASSIGNMENTS FOR PIN 1 ORIENTATION IN TAPE


*All dimensions are nominal

| Device | Package Type | Package Drawing | Pins | SPQ | Reel Diameter (mm) | Reel Width W1 (mm) | A0 (mm) | B0 (mm) | K0 (mm) | P1 (mm) | W (mm) | Pin1 Quadrant |
|------------------|--------------|-----------------|------|------|--------------------|--------------------|---------|---------|---------|---------|--------|---------------|
| LME49720MAX/NOPB | SOIC | D | 8 | 2500 | 330.0 | 12.4 | 6.5 | 5.4 | 2.0 | 8.0 | 12.0 | Q1 |

TAPE AND REEL BOX DIMENSIONS


*All dimensions are nominal

| Device | Package Type | Package Drawing | Pins | SPQ | Length (mm) | Width (mm) | Height (mm) |
|------------------|--------------|-----------------|------|------|-------------|------------|-------------|
| LME49720MAX/NOPB | SOIC | D | 8 | 2500 | 367.0 | 367.0 | 35.0 |

TUBE


*All dimensions are nominal

| Device | Package Name | Package Type | Pins | SPQ | L (mm) | W (mm) | T (μm) | B (mm) |
|-----------------|--------------|--------------|------|-----|--------|--------|--------|--------|
| LME49720NA/NOPB | P | PDIP | 8 | 40 | 502 | 14 | 11938 | 4.32 |



D0008A

PACKAGE OUTLINE

SOIC - 1.75 mm max height

SMALL OUTLINE INTEGRATED CIRCUIT



NOTES:

1. Linear dimensions are in inches [millimeters]. Dimensions in parenthesis are for reference only. Controlling dimensions are in inches. Dimensioning and tolerancing per ASME Y14.5M.
2. This drawing is subject to change without notice.
3. This dimension does not include mold flash, protrusions, or gate burrs. Mold flash, protrusions, or gate burrs shall not exceed $.006$ [0.15] per side.
4. This dimension does not include interlead flash.
5. Reference JEDEC registration MS-012, variation AA.

EXAMPLE BOARD LAYOUT

D0008A

SOIC - 1.75 mm max height

SMALL OUTLINE INTEGRATED CIRCUIT



LAND PATTERN EXAMPLE
 EXPOSED METAL SHOWN
 SCALE:8X



SOLDER MASK DETAILS

4214825/C 02/2019

NOTES: (continued)

- 6. Publication IPC-7351 may have alternate designs.
- 7. Solder mask tolerances between and around signal pads can vary based on board fabrication site.

EXAMPLE STENCIL DESIGN

D0008A

SOIC - 1.75 mm max height

SMALL OUTLINE INTEGRATED CIRCUIT



SOLDER PASTE EXAMPLE
BASED ON .005 INCH [0.125 MM] THICK STENCIL
SCALE:8X

4214825/C 02/2019

NOTES: (continued)

8. Laser cutting apertures with trapezoidal walls and rounded corners may offer better paste release. IPC-7525 may have alternate design recommendations.
9. Board assembly site may have different recommendations for stencil design.

P (R-PDIP-T8)

PLASTIC DUAL-IN-LINE PACKAGE



- NOTES:
- A. All linear dimensions are in inches (millimeters).
 - B. This drawing is subject to change without notice.
 - C. Falls within JEDEC MS-001 variation BA.

IMPORTANT NOTICE AND DISCLAIMER

TI PROVIDES TECHNICAL AND RELIABILITY DATA (INCLUDING DATA SHEETS), DESIGN RESOURCES (INCLUDING REFERENCE DESIGNS), APPLICATION OR OTHER DESIGN ADVICE, WEB TOOLS, SAFETY INFORMATION, AND OTHER RESOURCES "AS IS" AND WITH ALL FAULTS, AND DISCLAIMS ALL WARRANTIES, EXPRESS AND IMPLIED, INCLUDING WITHOUT LIMITATION ANY IMPLIED WARRANTIES OF MERCHANTABILITY, FITNESS FOR A PARTICULAR PURPOSE OR NON-INFRINGEMENT OF THIRD PARTY INTELLECTUAL PROPERTY RIGHTS.

These resources are intended for skilled developers designing with TI products. You are solely responsible for (1) selecting the appropriate TI products for your application, (2) designing, validating and testing your application, and (3) ensuring your application meets applicable standards, and any other safety, security, regulatory or other requirements.

These resources are subject to change without notice. TI grants you permission to use these resources only for development of an application that uses the TI products described in the resource. Other reproduction and display of these resources is prohibited. No license is granted to any other TI intellectual property right or to any third party intellectual property right. TI disclaims responsibility for, and you will fully indemnify TI and its representatives against, any claims, damages, costs, losses, and liabilities arising out of your use of these resources.

TI's products are provided subject to [TI's Terms of Sale](#) or other applicable terms available either on [ti.com](https://www.ti.com) or provided in conjunction with such TI products. TI's provision of these resources does not expand or otherwise alter TI's applicable warranties or warranty disclaimers for TI products.

TI objects to and rejects any additional or different terms you may have proposed.

Mailing Address: Texas Instruments, Post Office Box 655303, Dallas, Texas 75265
Copyright © 2023, Texas Instruments Incorporated