

Extrusion

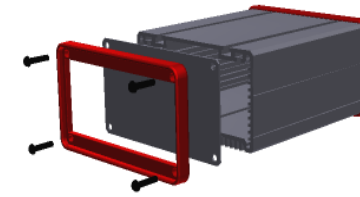

Slot Details

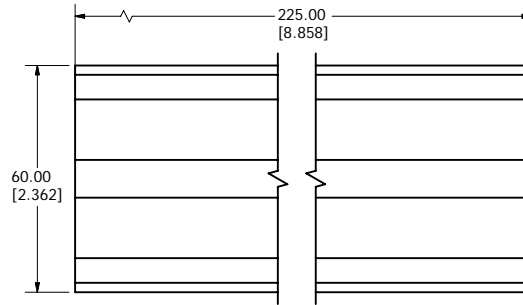
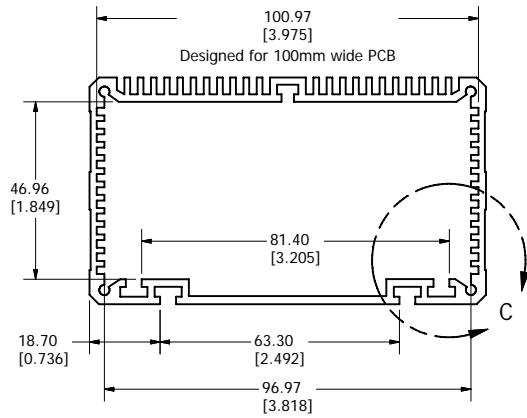
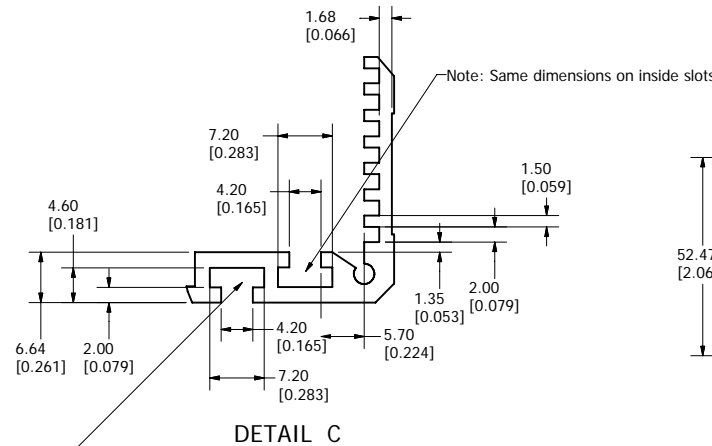

End Plate

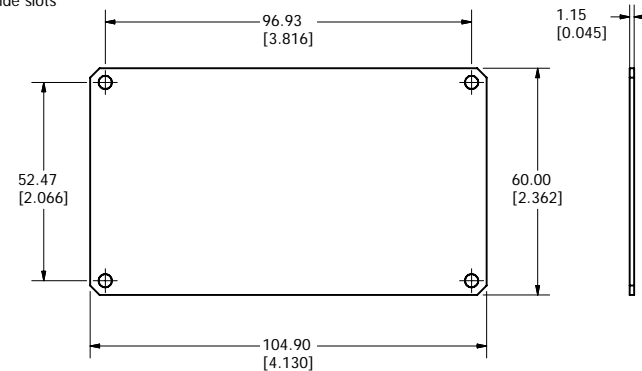

Note: Same dimensions on outside slots

Bezel

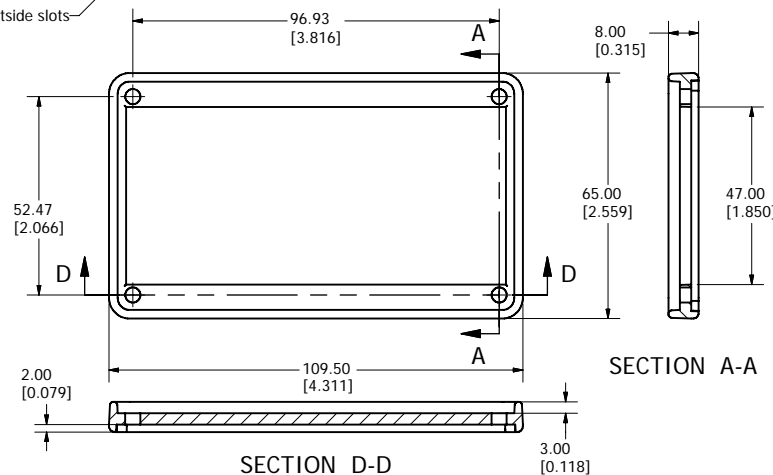

NOTE
Purchased assembly includes Extrusion, 2 End Plates, 2 Bezels and 8 screws

PART NUMBERS		
Sink Box		
Material	Colour	Part Number
Aluminum	Black Anodized	431622
6063 T5 Alloy	Clear Anodized	531622
Bezel	Black	
GP ABS		
End Plate	Black Anodized	031624
5052-H32 Alloy	Clear Anodized	131624
Required Torque on Fasteners (no lubrication)		
#4 x 0.5 Screws		30-40 cN*m

**HAMMOND
MANUFACTURING™**

105x225 Sink Box
www.hammondmfg.com